



K-LiTE
Product Portfolio

CONTENTS

02	About the Company
10	Bollards
20	Decorative Elements
28	Column Lights
31	Wall Luminaires
35	Bulk Head Luminaires
36	Path Finders
42	Ceiling Luminaires
44	Recessed Ceiling Luminaires
46	Garden Spot Lights
52	Flood Lights
54	In-Ground Luminaires
58	Linear In-Ground Luminaires
60	Linear Wall Washers
62	Cove Lighting
64	Underwater Luminaires
65	IP67 Linear Profiles
85	Pole Top Luminaires
90	Street Lighting Luminaires
98	Pathway Luminaires
104	Polar Street Lighting Luminaires
107	Indoor Luminaires
125	Industrial Luminaires
126	Linear Lighting
130	Architectural Linear Lighting



ABOUT US

In 1977, a dream was realized - to manufacture high-quality luminaires and Architectural lighting poles with a deep-rooted pursuit for excellence. With this vision, K-LITE was born. Every idea begins with an objective to achieve. Ours was to put a new spin on lighting products, keeping quality, sustainability, and energy efficiency at the core of everything we do. A registered trademark in India, UK and Europe, K-LITE works with the mission to add tangible value to the world of lighting.

To consolidate our commitment for excellence, we perform all our processes internally - from design and development to production and assembly, and we take great pride in being the manufacturer of choice for all lighting need.

Architectural Luminaires Inspired by You

Guided by a culture of continuous improvement and customer focus, our collection of finely crafted lighting is made using the highest quality materials. Over the years, our innovative architectural luminaires have lit several commercial, retail, and institutional establishments, and we could not be happier. As we continue to partner with architects, lighting designers and electrical contractors, our focus lies in bringing life to their lighting ideas. With seven state-of-the-art manufacturing plants, located in Chennai and Bhopal in India, we deliver high-quality architectural lighting solutions worldwide. And we do this with the support of over 750 passionately driven employees. A strong team. Incomparable performance. Client-centric approach defines us. This is what makes K-LITE an industry leader that aims to deliver nothing but the best.

Your Go-To Resource for **Architectural Lighting**

With a growing global footprint, K-LITE has successfully grown into one of India's leading manufacturers of architectural lighting poles & luminaires, be it contemporary or decorative. And we have done this by capitalizing on our industry knowledge and combining it with advanced optical engineering. Building the foundation of a solid interplay between architecture and luminaire, all our innovations and designs are shaped to enrich people's lives. Lighting refined.

46
YEARS
OF CREATIONS



HISTORY

At K-LITE, we are more than a lighting company. We are a "quality and people conscious" company.

Originating with the passion for transforming the lighting industry and inspired by research and designs that leave a mark, K-LITE has been designing and producing superior lighting solutions since 1977.

Today, K-LITE represents four-decade-long progress backed by quality and consistency and has evolved into one of India's leading architectural lighting manufacturers, with its presence in several global markets.

From the day we began our journey through the decades we have spent becoming the global brand that we are today, at every step phase, every achievement, we have been unlocking the remarkable ability of light to brighten the world.

K-LITE's rich history of putting values into action reflects that our aim to create a better world with quality lighting solutions is more than just text on the screen. It is our way of life.

FULLY CUSTOMIZED DESIGNS

Indoor or outdoor. Architectural or technical. Small or large.

At K-LITE, we offer a full range of lighting solutions for every project.

Our tailored designs are based on your requirements. And while producing what you want, we make sure to comply with our quality, sustainability, and reliability standards – setting elite benchmarks in the lighting world. The aim is to offer you luminaires that do not just illuminate but transform your setting with elegance galore. For the four decades of our operations, we have been a trusted choice for major railways, metros, and heritage lighting projects.

But this is just the beginning.

With excellence as the driving force, our bespoke designs aim to create a premier lighting community that rests on high-quality, high performance luminaires and poles.

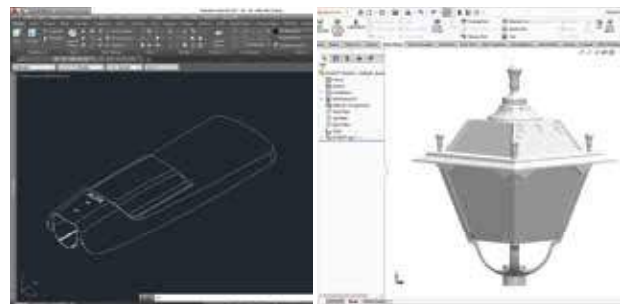

AutoCad

Solidworks

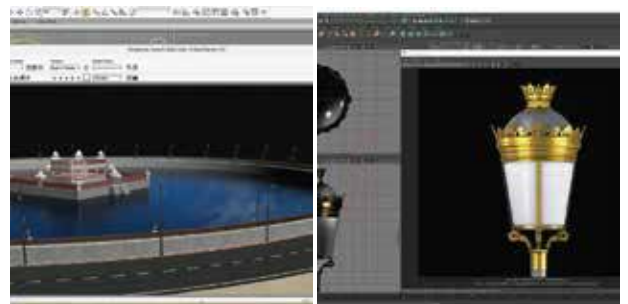

3ds Max

Maya



MANAGEMENT CERTIFICATIONS

At K-LITE, we believe in delivering you the best lighting solutions, which starts with ensuring that our products are developed with the best processing techniques and a mindful corporate policy.

Driven by quality, K-LITE celebrates certifications that represent unparalleled performance in everything we do.

LOCATION WE MAKE THE DIFFERENCE

At K-LITE, we rely on local competence for all our design, production, implementation, and management solutions. And this is reflected in our seven specialized manufacturing locations in India.

To deliver ease of accessibility to our clients, we have sales branches and partners spanning across the globe.

This robust and collective presence of K-LITE enables us to be a world-leading manufacturer of energy efficient lighting solutions.

Further to strengthen our Make-In-India mission “K-Lite has a dedicated state-of-the art plant at Bhopal for urban cityscape range of poles”.



PRODUCTION AND ASSEMBLY

Smart lighting solutions require processes that are carefully monitored by experts.

This focus on processes is part of K-LITE's DNA.

Since 1977, we have been giving special attention to detail when it comes to our manufacturing techniques. And our focus on quality and efficiency is not restricted to a particular process. From electronics and tool manufacturing to acrylics, pole manufacturing and metalwork, quality and efficiency get the top priority at every step of production.

Control over materials helps us strike a perfect balance between quality and aesthetics, bringing excellent lighting pieces to life.

Whether it is the quality light output, CRI, or thermal management of a luminaire, we design lighting systems that are crafted with excellence in mind. Our production processes are continuously streamlined to deliver longer product life, lower energy consumption, minimum operating temperatures, together with fantastic light yield, and more.

Success at K-LITE means a continuous search for innovation. That is the reason why our manufacturing plants are equipped with advanced technology, operated by seasoned engineers.

Be it CNC robotic fabrication, surface mount technology (SMT) line, shot blasting, or 2D/3D milling - we have got you covered with the latest in the world of lighting technology, delivering products that are perfect for your project.

At K-LITE, suppliers are considered strategic partners, working with the commitment to excel together. This excellence in channel partnership extends to customer service, ensuring the shortest delivery times and long-lasting relationships.



IN-HOUSE DESIGN

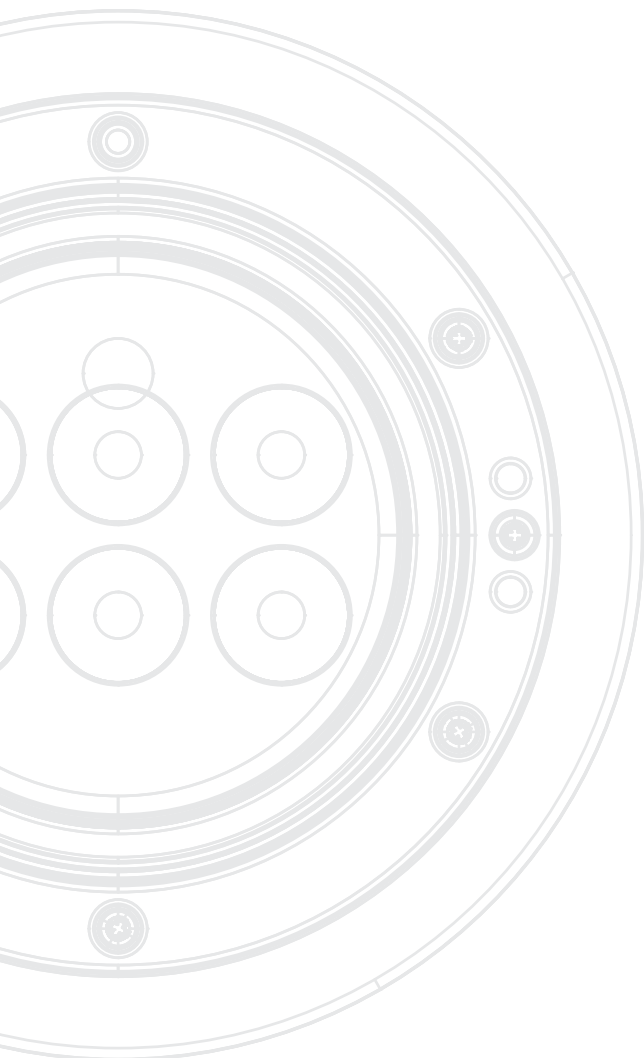

OPTICS

Creating lights that provide the impression of infinite space isn't easy. But at K-LITE, we have always loved challenges.

We use optical systems that make optimized light distribution a reality. With durable, wear-resistant optics, our products deliver light that's full, uniform and ensure maximum efficiency.

Addressing light distribution and zonal intensity's importance in delivering uniform lighting, K-LITE has collaborated with some of the world's best-known optical manufacturers. Relying on the highest quality LED lenses and reflectors, our solutions ensure that light spreads efficiently, and designers obtain the lighting effect that best matches their requirements.

High efficiency, resistance to age-related deterioration, and superior illumination. All the right boxes ticked.

Pioneering breakthroughs in the lighting industry is no mean feat. And who understands it better than K-LITE. Since the very beginning, we have been focused on design and technology that make a difference.

We challenge ourselves with market research and feedback that generates what is missing in the lighting world. That is why we have succeeded in creating a range of architectural lighting solutions that meet our customers' requirements, along varied industries, and venues.

But that does not mean we do not value sustainability. K-LITE is one of the very few names that focus on minimalism while building designs that are powered by creativity. We do this keeping the latest trends in mind. Together with our attention towards aesthetics and functionalities like thermal management and glare control, we have been able to go beyond the conventional designs.

Our love for continuous improvement and our passion for inhouse testing has helped us bring a range of architectural lighting that outshines when it comes to longevity, optical performance, and efficiency.

We make lighting intelligent. And we do that by delivering an ecosystem for our customers, designers, and partners. An ecosystem that is fueled by innovation and customization.

Yes, customization forms an integral part of our solutions. And you should not wonder why.

Think of it this way: your lighting project deserves unique solutions. By customizing lighting, we aim to deliver you the quality you seek. After all, no two lighting projects are the same. So why should the solutions be?

Whether you want to upgrade your commercial establishment's luminaires or going for a new project altogether, we deliver solutions that are specific to your needs. This is one of the many reasons why K-LITE has been able to grow its product references to a massive 5,000 in numbers.

And as we say, this is just the beginning.

Our entire design and development facility, managed by our Chennai Headquarters, strives to excel, just like every other process at K-LITE. We enjoy making light. And intelligent designs are what keep us going.

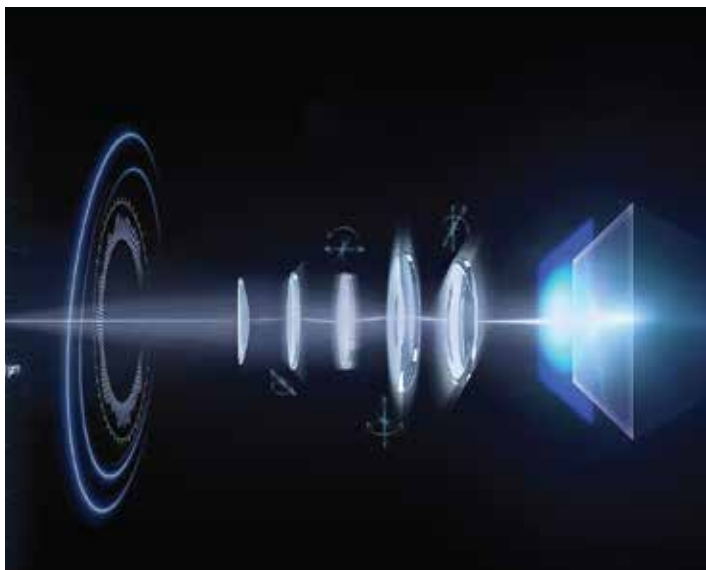



METALS AND FINISHES

At K-LITE, we go by one rule: our luminaires and poles should give more than just radiant light. That is why we put a lot of effort into material finishes, processing, and surface protection. It is through meticulous sealing of surfaces that we deliver products with high corrosion resistance and clean aesthetics.

The process begins with inhouse blasting to remove impurities from the surfaces. Varied size shots are used as abrasives and run through the line at a controlled speed. Once done, a priming coat of zinc is applied. Finishing is performed with the desired RAL color.

Blasting is one of the critical processes at K-LITE. Besides removing residual impurities on surfaces, it also increases paint adhesion. Plus, it sets the base for the primer process, which is done to prevent the newly exposed surface from oxidation. Priming also helps in furthering the corrosion resistance of surfaces. The coat is applied with a coating thickness greater than 60 microns.

The final finish is as important as any part of the process. It is done with the desired RAL color of UV-stabilized polyurethane based paint or polyester powder coating. The end results?

Long-lasting finish that adds dimension to the product while giving it a unique expression.

OUR CORE VALUES

Innovation

Innovation is what leads to growth. With a zeal to adapt to the ever-changing dynamics of the lighting world, we are devoted to innovation and efficiency. We determine the changes our systems, processes, and products require to deliver relevance to our customers. It is this drive to evolve and innovate that helps us bring success onboard.

Integrity

What would the world be without integrity? Certainly not the one K-LITE strives to create. We believe that gaining customers may be easy. But to retain them, you need to honor integrity. This is the reason why constancy and transparency form the core of our operations. Call it our honesty or trustworthiness, but we believe in building a community that rests on sincerity and strong work ethics.

Quality

What makes us different from the rest? Our undying commitment to excellence. Quality is what has helped us emerge as a leader in the world of lighting solutions. To ensure that our products and processes don't fail to meet the global standards of quality, we continually invest in technology and train our team to deliver solutions that the world deserves, not just needs.

Passion

Doing what you love is crucial for long-term success. Our passion for work inspires us to keep moving ahead. As a company that drives change in the lighting industry, passion is evident in every part of our organization. And it is the very same passion that we look for while bringing people in our team.

Relationship

With the commitment to serve our customers with quality, we strive to create relationships that go beyond financial transactions. And as a people-centric business, we foster our relations with our coworkers too. By building healthy and happy relationships, we aim to be the best place to work and partner with.

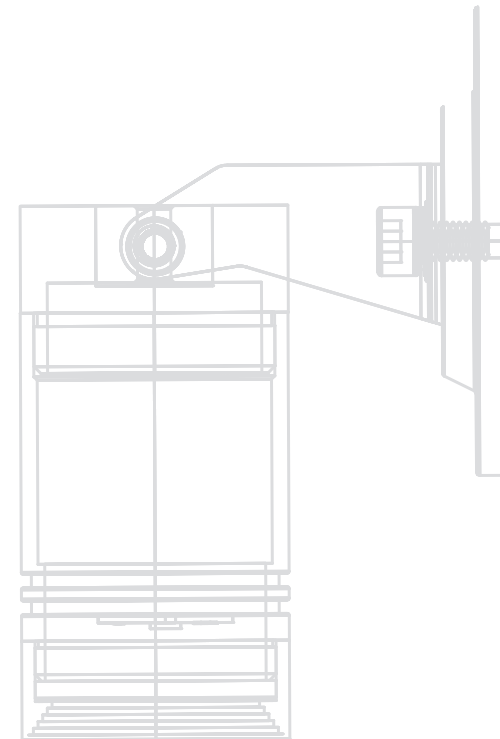

ILLUMINATION

LAB

There's this thing about lighting – you need to continually evolve and improve luminaires to meet the ever-changing needs of the customers.

At K-LITE, our innovative NABL Certified lab is equipped with state-of-the-art technological solutions to focus on optics, electronics, thermal, and IP/IK ratings along with other parameters that impact efficiency and compatibility of lighting.

Before undergoing production, all our products are first validated in our lab to attain lower power consumption, minimum operating temperatures, excellent light yield, and longer product life.

We ensure all the required specifications are met to deliver you energy that is reliable and sustainable.



C Type GO R-5000 Goniophotometer

QUALITY CONTROL



Integrating sphere



Glow Wire Test



Salt Spray Chamber



IK Testing



Jet Test



Rain Test

Innovation is an essential cornerstone of K-LITE. Extensive research and development empower us to bring new solutions to the lighting industry. And we are proud of this never-ending commitment to quality that guides us.

Spearheaded by the company founder and chief engineer, Mr. Dilip Kumbhat, our dedicated in-house team of skilled engineers and designers comes with years of experience in the lighting industry. It is this experience and knowledge that helps them innovate and excel.

With industry-leading scientific tools and technology, including 3D printing, early-stage prototyping, goniophotometer, and inhouse manufacturer testing, we create energy-efficient lighting products and systems based on your business needs. Making value for time and resources, we follow stringent quality measures throughout the production process and beyond.

Give credit to our superior attention to detail or the rigorous testing of our products, but everything we do is to serve you better. We believe that high-quality products can only be manufactured and delivered when there's a system of high quality testing in place.

Our advanced lab ensures that safety standards are met for every luminaire which is conceptualized and produced at K-LITE. This is what has helped us to exceed your expectations, with each product that we have delivered - because every single product is thoroughly inspected and tested at K-LITE.

What do you get?

Maximum efficiency, with complete peace of mind.



CORPORATE SOCIAL RESPONSIBILITY

Over the years, we have successfully anchored responsible actions in the K-LITE's philosophy, and contributed towards a stable ecological, economic, and social framework in the following ways:

- Making our electricity consumption carbon neutral with the installation of over 2000 solar panels which generate 300kWp.
- Creating an efficient circular economy by recovering reusable materials and recycling components.
- Ensuring no use of hazardous substances in our production process.
- Minimizing water consumption and implementing rainwater harvesting in our units.
- Phasing out plastic with a "NO Plastic" policy.
- Using recycled materials for packaging with the least use of plastic and Styrofoam.
- Investing in our people through skill and leadership development.
- Transforming lives and communities through activities necessary for social and economic progress such as educational scholarships and grants to children from weaker sections.

K-LITE works with the belief that only better lighting is not enough to change the world. We must align our products, systems, and processes to create a more sustainable future.

We are working for a brighter and better tomorrow - at every step.

GLOBAL PRESENCE

We are not just manufacturing our product for limited area of our country. We also export our product to more than 20 countries and counting.



AND COUNTING

SLIMMY

Sleek Form
Superior Visual Comfort

These flower bed luminaire is a combination of low height tube. These luminaries offer shielded glare free illumination of ground surface and are perfect for illuminating entrances, footpaths as well as garden and landscape architecture. Clean Lines and pure form are the underlying elements of this series of LED bollards, designed to provide light emission of 360°.

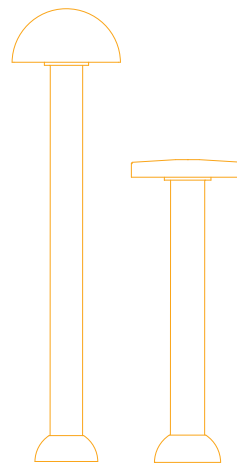



MEXICAN SLIMMY BOLLARD

4704	6W LED M29	Ø140 x 920
4705	6W LED M29	Ø140 x 620
4706	6W LED M29	Ø140 x 320



BAMBOO BOLLARD

4707	6W LED M29	Ø125 x 1000
4695	6W LED M29	Ø125 x 700

K-LITE

Slimmy Series



CORVUS HYBRID BOLLARD

4718	12W LED M9	Ø210 x 758
4719	12W LED M9	Ø210 x 558



MUSHROOM BOLLARD

5582	16W LED M9	Ø168 x 703
5583	16W LED M9	Ø168 x 503



MUSHROOM - FLAT TOP BOLLARD

5591	16W LED M9	Ø166 x 645
5592	16W LED M9	Ø166 x 445



MEXICAN BOLLARD - PYRO TOP

4671	8W LED M2	Ø194 x 1000
4672	8W LED M2	Ø194 x 475
4673	8W LED M2	Ø194 x 325



MEXICAN MAYA BOLLARD - PYRO TOP

4680	8W LED M2	Ø194 x 1000
4681	8W LED M2	Ø194 x 475
4682	8W LED M2	Ø194 x 325



RITU BOLLARD
Colour : Graphite Grey Only

6951	9W LED M5	Δ130 x 800
6952	9W LED M5	Δ130 x 500
6953	9W LED M5	Δ130 x 200
6954	9W LED W32	170 x 130 x 200



K-LITE
100 Series



CIRCO - CUTOFF BOLLARD

6963	E27-E M6	176 x 168 x 1000
6964	E27-E M6	176 x 168 x 500
6965	E27-E M6	176 x 168 x 300



ROMAN ROUND MIDI ROOK

4543	E27-B M2	Ø250 x 950
4544	12W LED M2	Ø250 x 950



PRINCE ORNA ROOK

4535	E27-B M2	Ø293 x 1045
4536	15W LED M2	Ø293 x 1045



SLEEK AJNA CRESCENT BOLLARD

7062	8W LED M2	Ø100 x 900
7063	8W LED M2	Ø100 x 410
7064	8W LED M2	Ø100 x 270



SLEEK AJNA BOLLARD

5558	8W LED M2	Ø100 x 900
5559	8W LED M2	Ø100 x 410
5560	8W LED M2	Ø100 x 270



SLEEK VERA BOLLARD

5568	8W LED M2	Ø100 x 1005
5569	8W LED M2	Ø100 x 515
5570	8W LED M2	Ø100 x 375



SLEEK BOLLARD - FLAT TOP

4823	8W LED M2	Ø106 x 1015
4825	8W LED M2	Ø106 x 525
4827	8W LED M2	Ø106 x 385



TRIO BOLLARD

6955	E27-E M5	Δ130 x 1000
6956	E27-E M5	Δ130 x 500
6957	E27-E M5	Δ130 x 300



SLIMMY TORCH BOLLARD

4778	24W LED M2	Ø106 x 975
------	------------	------------





K-LITE
166 Series



CARLEY ROUND BOLLARD
4709 12W LED M3 Ø166 x 1000



VAJRA BOLLARD Top option : Round
4841 16W LED M3 Ø166 x 971
4842 16W LED M3 Ø166 x 506



AJNA BOLLARD
5561 16W LED M3 Ø166 x 895
5562 16W LED M3 Ø166 x 430
5563 16W LED M3 Ø166 x 235



VERA BOLLARD
5565 16W LED M3 Ø166 x 971
5566 16W LED M3 Ø166 x 505
5567 16W LED M3 Ø166 x 310



AJNA SLICE BOLLARD
4731 12W LED M3 Ø166 x 952
4732 12W LED M3 Ø166 x 487
4749 12W LED M3 Ø166 x 290

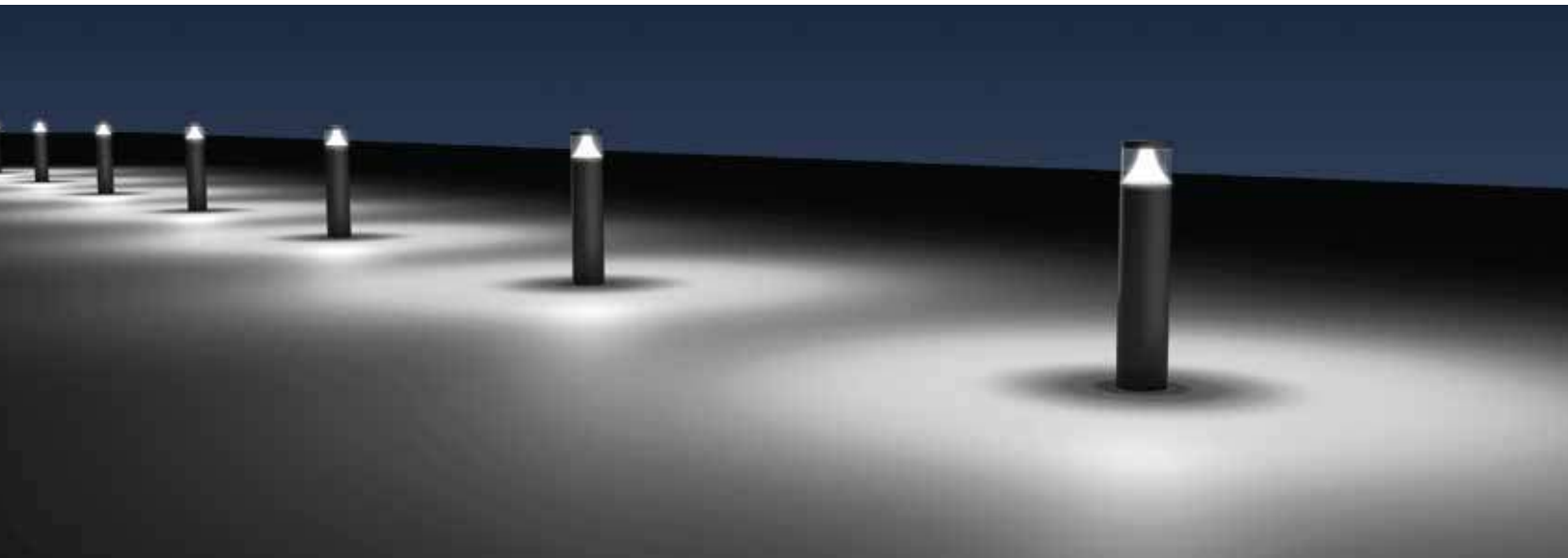

Lighting Effect & Planning

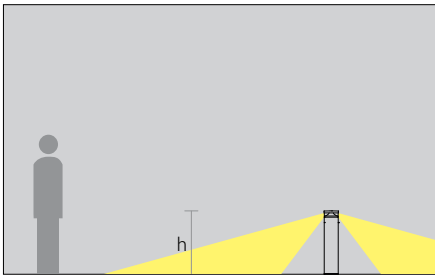

Ajna

Ajna bollard with rotationally symmetrical light distribution for the illumination of pathways or squares.

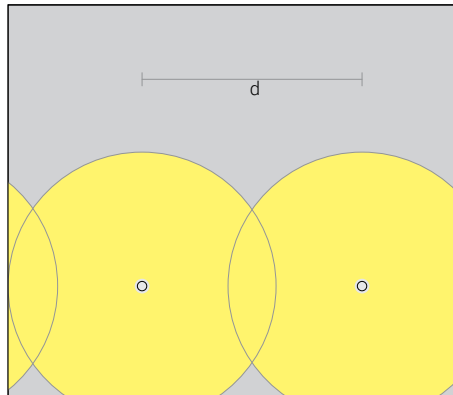

The 360° lightemission of Ajna bollard lends itself to the uniform illumination of squares and open areas. The spacing (d) between two luminaires ($h \geq 800\text{mm}$) may be up to 10m. Other distances can be selected to support optical guidance.

K-LITE

200 Series



AJNA BOLLARD

4758	24W LED M42	Ø200 x 906
4759	24W LED M42	Ø200 x 406



VERA BOLLARD

4789	24W LED M42	Ø200 x 1000
4790	24W LED M42	Ø200 x 500



VIRGO BOLLARD

4761	24W LED M42	Ø200 x 972
4762	24W LED M42	Ø200 x 472



K-LITE

Square Series



CARLEY SQUARE BOLLARD
 4710 12W LED M36 □150 x 1000
 4708 12W LED M36 □150 x 250



POLAR QUAD ASY BOLLARD
 4729 12W LED M37 □100 x 1000
 4730 12W LED M37 □100 x 700



CUBA BOLLARD
 6976 E27-E M7 □121 x 1005
 6977 E27-E M7 □121 x 505
 6978 E27-E M7 □121 x 305



NIMBUS BOLLARD
 4726 16W LED M7 □121 x 1000
 4727 16W LED M7 □121 x 525
 4728 16W LED M7 □121 x 325





K-LITE

R80 Series



POLAR BOLLARD
7069 12W LED M47 270 x 80 x 1000



DUO POLAR BOLLARD
4773 2 x 12W LED M47 500 x 80 x 1000



MORA BOLLARD
4764 12W LED M47 325 x 80 x 1000



MARCONA BOLLARD
4763 12W LED M47 325 x 80 x 500

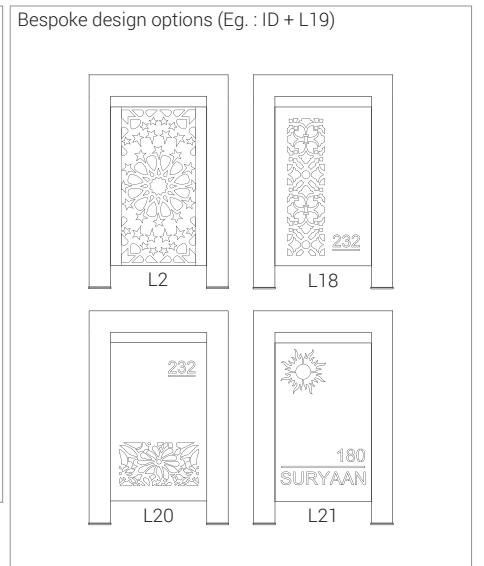

JADO

Impressive Form Optimum Performance

A decorative LED bollards designed to provide soft, uniform light. These luminaries offer shielded glare free illumination of ground surface and are perfect for illuminating entrances, footpaths as well as garden and landscape architecture. Clean Lines and pure form are the underlying elements of this series of LED bollards.

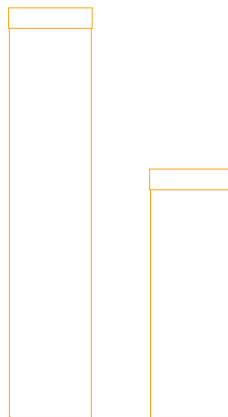



JADO WOOD BOLLARD

7399	12W LED M24	200 x 110 x 1000
7511	12W LED M24	200 x 110 x 600
7543	12W LED M24	200 x 110 x 300



DUO JADO WOOD BOLLARD

7544	2 x 12W LED M24	200 x 170 x 1000
7600	2 x 12W LED M24	200 x 170 x 600
7673	2 x 12W LED M24	200 x 170 x 300



JADO BOLLARD

7078	12W LED M24	200 x 110 x 1000
7100	12W LED M24	200 x 110 x 600
7200	12W LED M24	200 x 110 x 300



DUO JADO BOLLARD

7204	2 x 12W LED M24	200 x 170 x 1000
7208	2 x 12W LED M24	200 x 170 x 600
7212	2 x 12W LED M24	200 x 170 x 300



JADO WOOD / DUO JADO WOOD

4184	1 x 24W LED M35	300 x 160 x 2440
4185	2 x 24W LED M35	300 x 170 x 2440

JADO / DUO JADO

4186	1 x 24W LED M35	300 x 160 x 2440
4187	2 x 24W LED M35	300 x 170 x 2440

Special Finish On Request

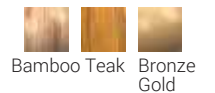

Bamboo Teak Bronze Gold

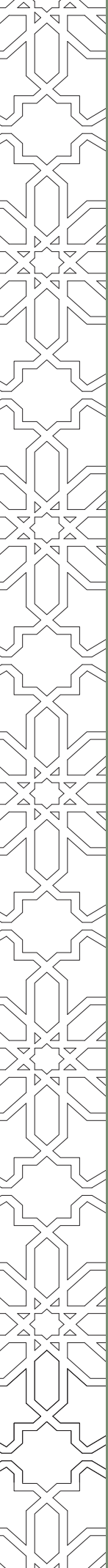

K-LITE



Elements

DESIGN SERIES

K-LITE



Non-Integral

STIX		
4554	3W LED	90 x 1106
4555	3W LED	90 x 1306
4556	3W LED	90 x 1506



STIX		
4553	3 x 3W LED M2	Ø313 x 1386

Special Finish On Request

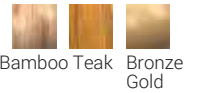

Bamboo Teak Bronze Gold



PARULA BOLLARD		
4720	1 x 3W LED M2	156 x Ø100 x 700
4722	2 x 3W LED M2	229 x 149 x 700
4724	3 x 3W LED M2	284 x 209 x 700



The Verbena bollard lights from K-Lite Lighting bring vitality and drama to landscape lighting applications. These decorative bollards project a compelling nature-inspired pattern downward onto the ground, adding a stunning pictorial drama to nighttime beauty of the landscape with excitement and fun.





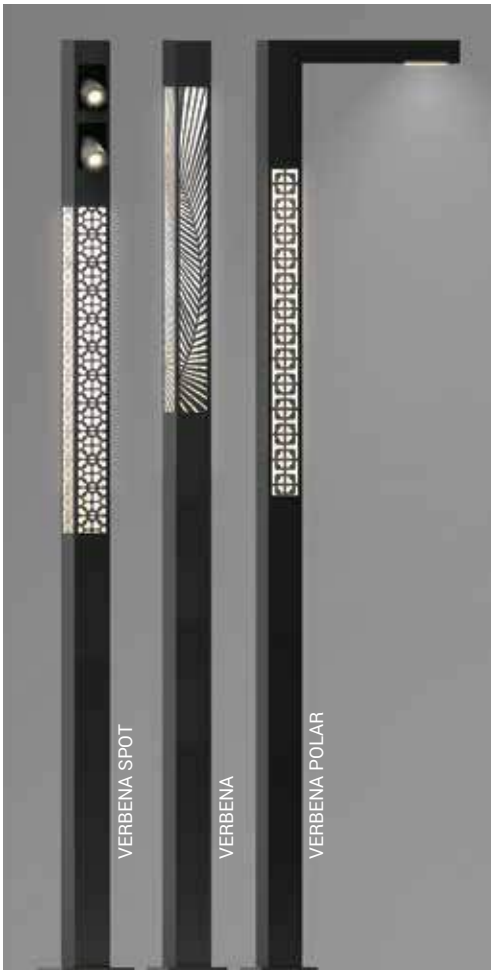

VERBENA SPOT	4583	2 x 18W & 50W LED M48	□150 x 4000
VERBENA	4585	50W LED M48	□150 x 4000
VERBENA POLAR	4584	2 x 50W LED M48	850 x 150 x 4000

Bespoke design options

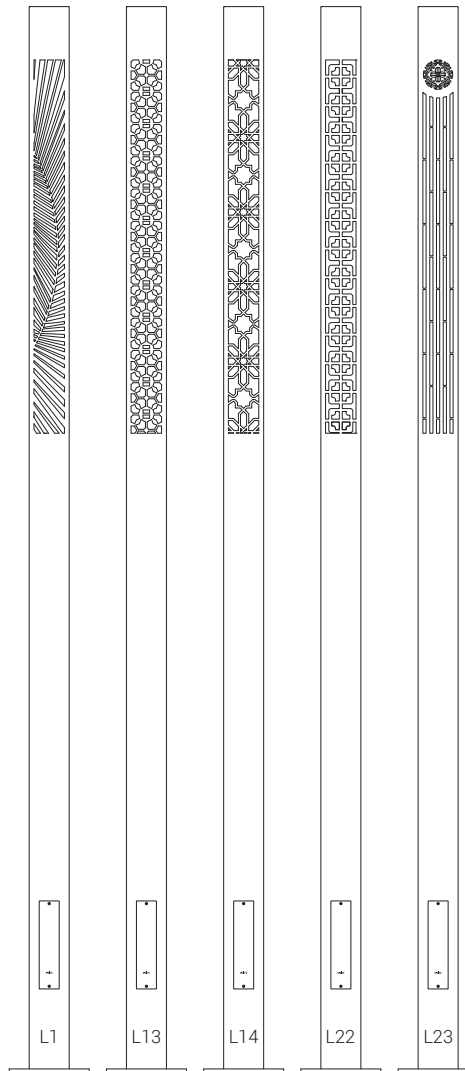

VERBENA BOLLARD	4735	12W LED M36	□150 x 910
------------------------	------	-------------	------------

Bespoke design options

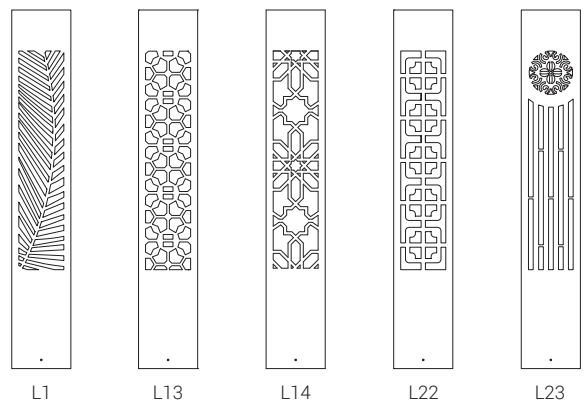

Column lights also add aesthetic value to any architectural project. They can be used to create a welcoming ambience, highlight architectural features and enhance the overall visual appeal of a space. They can be customized with different colours, finishes and lighting effects to create the desired look and feel.



Decorative Luminaires



CYRILLA
4336 12W LED W28 257 x 206 x 401



CYRILLA
4352 12W LED W28 257 x 206 x 326
4338 E27 W28 257 x 206 x 326



CYRILLA LEAF
4339 12W LED W28 257 x 206 x 326



CYRILLA PILLAR
4625 12W LED W28 □206 x 400



CYRILLA PILLAR
4626 12W LED W28 □206 x 366
4628 E27 W28 □206 x 366



CYRILLA LEAF PILLAR
4627 12W LED W28 □206 x 366



CYRILLA BOLLARD
4748 12W LED M36 □206 x 500
4737 12W LED M36 □206 x 324

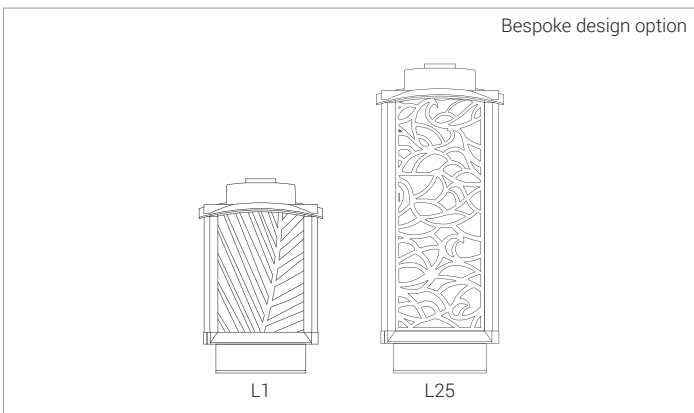

CYRILLA LEAF BOLLARD
4588 12W LED M36 □206 x 500
4589 12W LED M36 □206 x 324

One of the significant advantages of lighting bollards is that they can be used in a wide range of outdoor environments, including parks, residential, pathways, parking lots and public squares. They are also useful for highlighting architectural features. With their flexibility and versatility, bollards can be used to create a range of lighting effects from functional illumination to decorative and dramatic lighting.





Ø106 x 2640	7036							
COLUMN LIGHT	100 Series	COLUMN LIGHT		166 Series	COLUMN LIGHT		200 Series	
7036	24W LED M15	7021	24W LED M11	Ø166 x 2700	4666	100W LED M43	Ø200 x 5000	
		7020	48W LED M11	Ø166 x 3350	4668	100W LED M50	Ø200 x 4000	
		7018	100W LED M11	Ø166 x 4200	LUCY			
					4665	50W LED M43	Ø200 x 5000	
					4667	50W LED M50	Ø200 x 4000	



CARLEY ROUND

4754	40W LED M11	Ø166 x 3500
4661	40W LED M44	Ø166 x 4000

BA : 15°/25°/40°

CARLEY SQUARE

4755	40W LED M46	Sq.150 x 3500
4663	40W LED M48	Sq.150 x 4000

BA : 15°/25°/40°





JUNO
7034 60W LED M15 Ø600 x 3500



REFLECTO DIXON MEGA
4750 50W LED M11 Ø900 x 3554

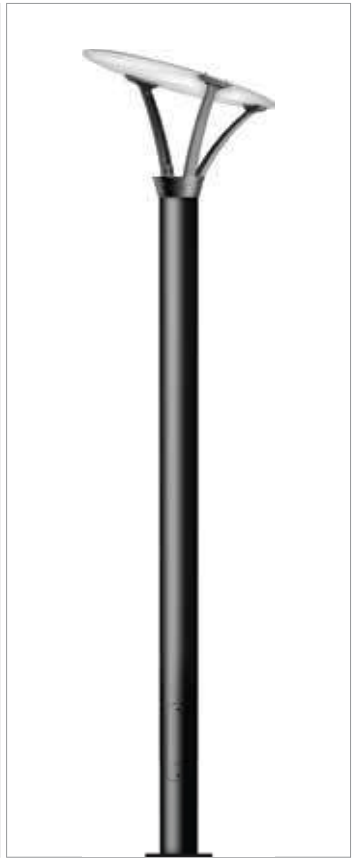

ANGLE DIXON
7030 50W LED M11 865 x 785 x 3660

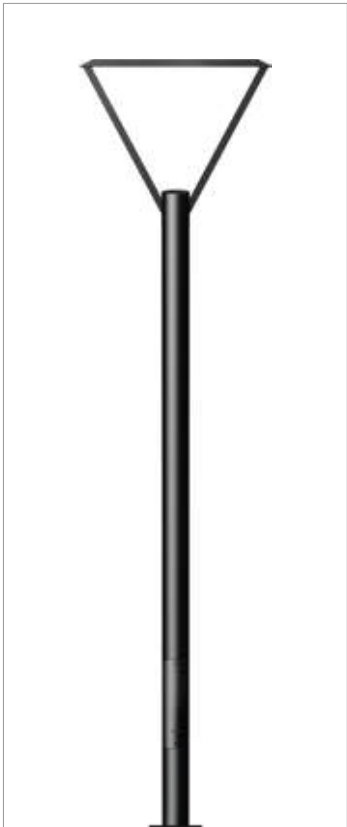

STENCIL
4238 40W LED M34 692 x 3000

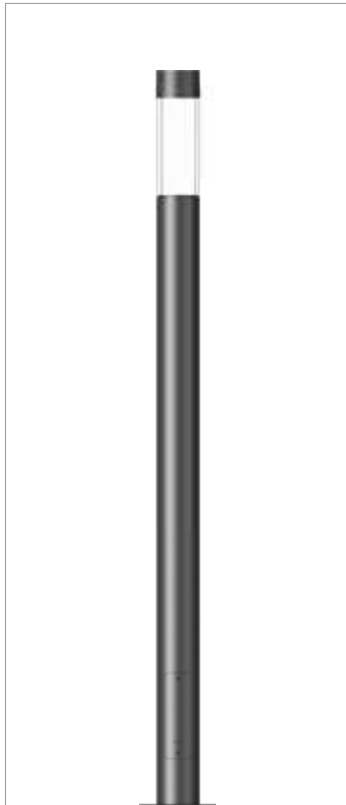

LUCY
7042 30W LED M11 Ø171 x 2980
4587 50W LED M11 Ø171 x 2980



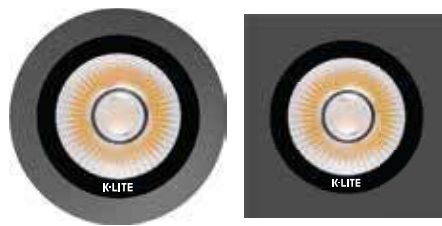

WALL LUMINAIRES

Precise Lighting Defined Lines

Wall mounted luminaires for grazing light in various applications suitable for interior & exterior installation. Perfect for accentuating vertical facade elements & providing ambient light along with floor washing options. The complete range of varied sizes and optical designs create striking light patterns on the wall surface.

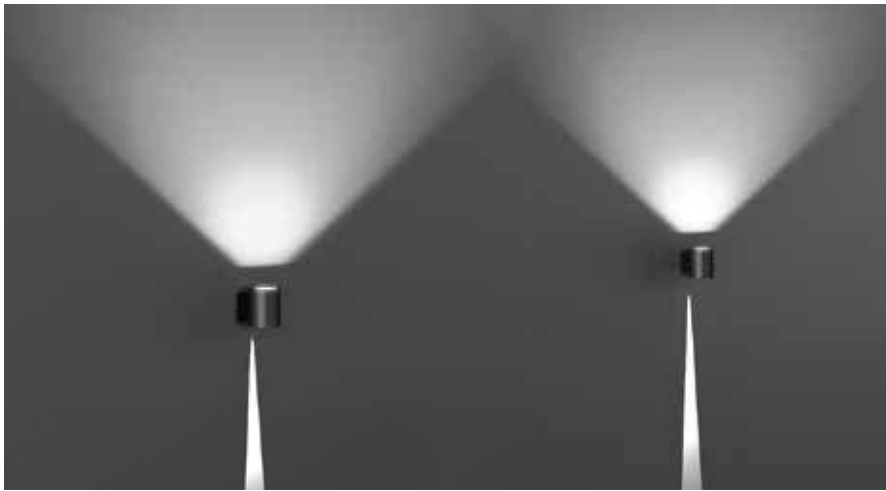
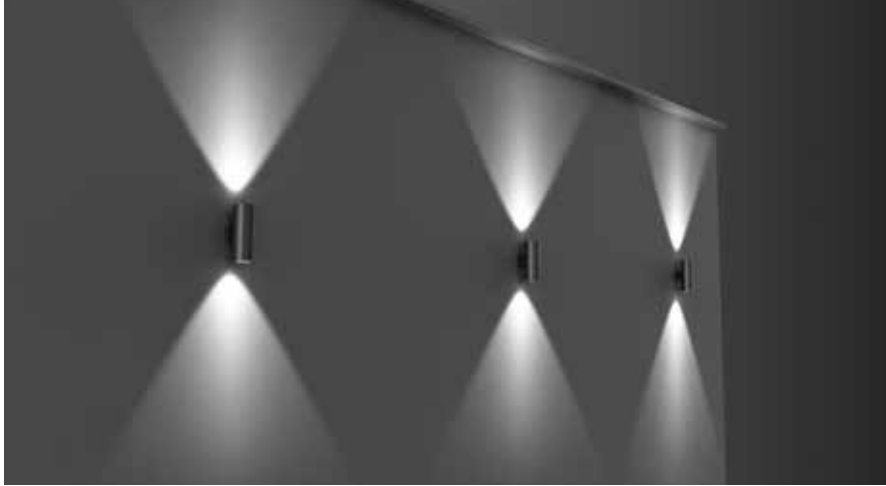

OPTICS



ACCESSORIES



HONEY COMB LOUVRE

Up Down Lighters



WALL TRIO

6984	1 x 6W LED W32	N11 172 x 129 x 200
6985	2 x 6W LED W32	N12 172 x 129 x 250
BA 25°		



WALL QUAD MINI

3635	1 x 6W LED W32	150 x 100 x 150
3637	1 x 12W LED W32	150 x 100 x 150
3639	1 x 18W LED W32	150 x 100 x 150



WALL QUAD MINI

3636	2 x 6W LED W32	150 x 100 x 210
3638	2 x 12W LED W32	150 x 100 x 270
3640	2 x 18W LED W32	150 x 100 x 270

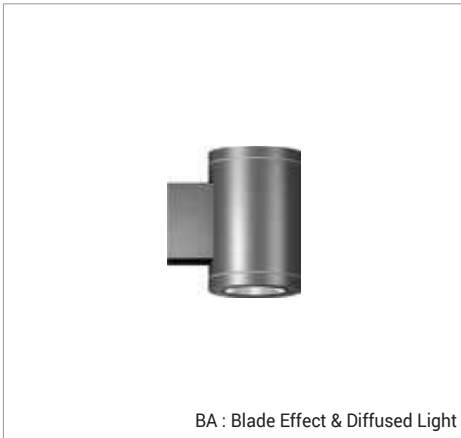

BA : Blade Effect & Diffused Light

WALL CYLIN BEAM

3634	3W & 6W LED W32	145 x 100 x 150
------	-----------------	-----------------



WALL CYLIN MINI

3666	1 x GU10 Holder W32	145 x 100 x 150
7897	1 x 6W LED W32	145 x 100 x 150
3653	1 x 12W LED W32	145 x 100 x 150
3650	1 x 18W LED W32	145 x 100 x 150



WALL CYLIN MINI

3667	2 x GU10 Holder W32	145 x 100 x 150
7898	2 x 6W LED W32	145 x 100 x 210



WALL CYLIN MINI

3654	2 x 12W LED W32	145 x 100 x 270
3651	2 x 18W LED W32	145 x 100 x 270



WALL CYLIN

3655	1 x 25W LED W33	216 x 166 x 200
3652	1 x 40W LED W33	216 x 166 x 200



WALL CYLIN

3656	2 x 25W LED W33	216 x 166 x 300
------	-----------------	-----------------

K-LITE

Wall Luminaires



WALL DENA
3665 6W LED W18 N12 111 x 108 x 94

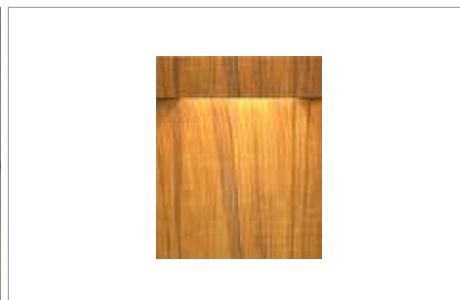

WALL JADO WOOD
4211 12W LED W28 N13 205 x 81 x 251

Special Finish On Request

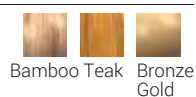

SLIMMY TORCH
4756 24W LED W32 148 x 105 x 765

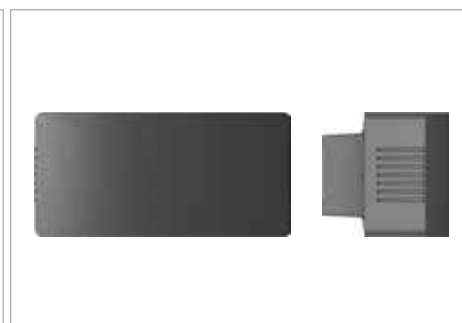

WALL CRESCENT
3776 1 x 40W LED N11/N12 368 x 180 x 178
3777 2 x 40W LED N11/N12 368 x 180 x 178



KARONA FORT MINI
5175 30W LED W23 N13 640 x Ø475 x 400
5268 30W LED W23 N13 640 x Ø475 x 400



Prismatic Polycarbonate

BRICKO

4070	2 x E27	130 x 116 x 250
5616	12W LED	130 x 116 x 250

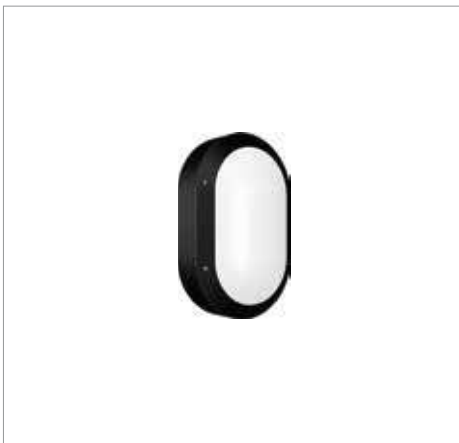

RORECTRA MINI - OPEN FRAME
4074 12W LED 133 x 59 x 217



RORECTRA MINI- HALF FRAME
4075 12W LED 133 x 62 x 217



RECTRA - HALF FRAME
4055 E27 185 x 84 x 280
4046 12W LED 185 x 84 x 280



FOCUS MIDI - HALF FRAME
5633 12W LED Ø271 x 71



FOCUS MIDI - Y FRAME
5634 12W LED Ø271 x 75



RECTRA HORIZON - HALF FRAME
4058 E27 280 x 84 x 185
4049 12W LED 280 x 84 x 185

Colour : Power Coated Black. IP54





ZEDO

WALL SURFACE

Compact and robust wall surface mount luminaires for illuminating ground surfaces. Available in different sizes and shapes with light outputs suitable for walkways, stairs, ramps and wherever a soft and functional illumination is required for orientation. High visual comfort makes Zedo a sleek and contemporary series of Pathfinders.

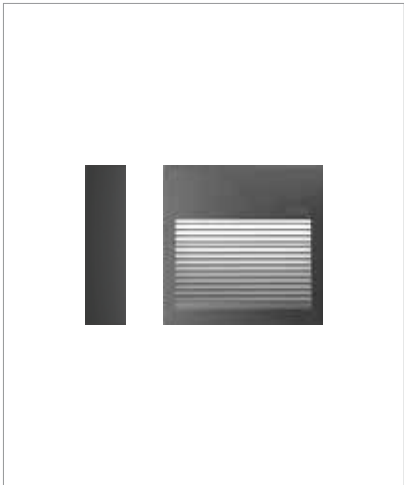

RADO MINI
2776 6W LED □105 x 38

Light Distribution

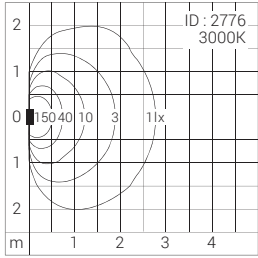

Applied Photometry : H=0.3m

- Note:
- Surface floor washer.
 - Recommended installation height : 300-500 mm
 - Recommended spacing : 3 metres

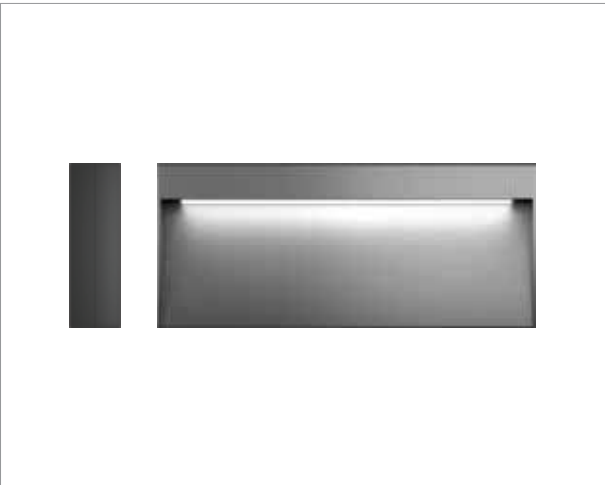

ZEDO
2767 12W LED 220 x 40 x 95

Light Distribution

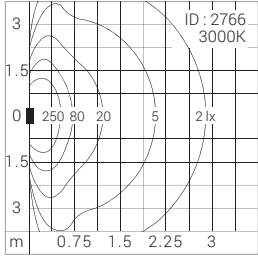

Applied Photometry : H=0.5m

- Note:
- Surface floor washer.
 - Recommended installation height : 500-700 mm
 - Recommended spacing : 3-4 metres

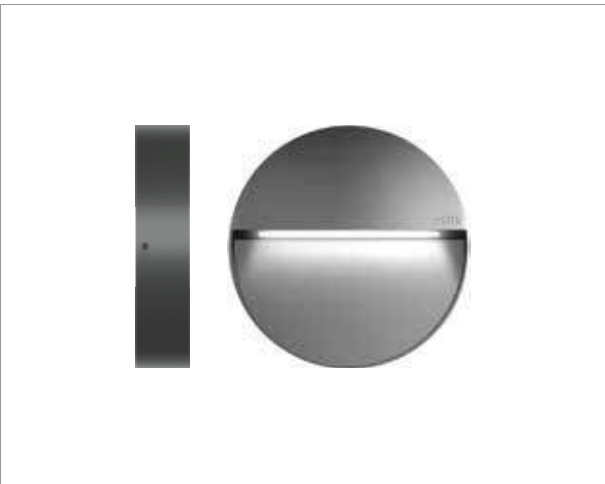

ZEDO ROUND
2766 12W LED Ø180 x 38

K-LITE
Surface Mounting
Path Finders



SUDO SLOT
4734 3W LED M47 80 x 54 x 225

Light Distribution

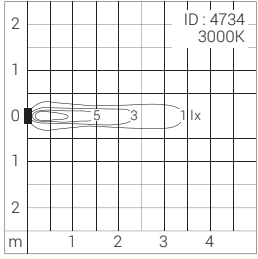

Applied Photometry : H=0.25m

- Note:
- Recessed Pathway / Staircase light.
 - Recommended installation height : 150-250 mm
 - Recommended spacing : Alternate Tread

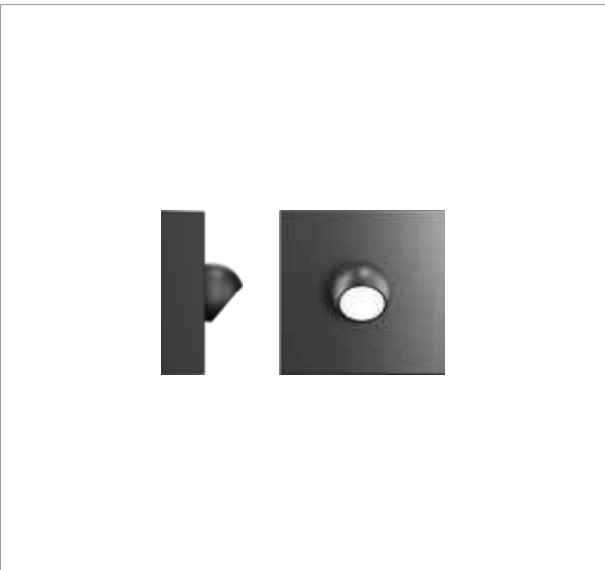

PARULA
4343 3W LED W28 □115 x 52



SUDO

WALL RECESSED

Precise Light Minimalist Design

Compact and robust wall recessed luminaires for illuminating ground surfaces. Available in different sizes and wattages for various indoor / outdoor applications, such as walkways, stairs, ramps and wherever a soft illumination is required for orientation. High visual comfort makes Sudo a sleek and contemporary series of Pathfinders.

K-LITE

Path Finders

2761 2768

SUDO MINI - SLOT / ARC C.O.D

2761 / 68	3W LED	76 x 87 x 130	70 x 83 x 124
-----------	--------	---------------	---------------

Light Distribution

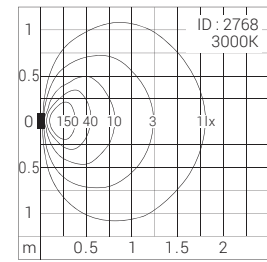

Applied Photometry : H=0.3m

Note:

- Recessed floor washer.
- Recommended installation height : 300 mm
- Recommended spacing : 500-700 mm

Light Distribution

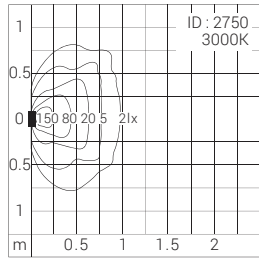

Applied Photometry : H=0.3m

Note:

- Recessed Staircase / Floor washer light.
- Recommended installation height : 200 - 300 mm
- Recommended spacing : Alternate Tread

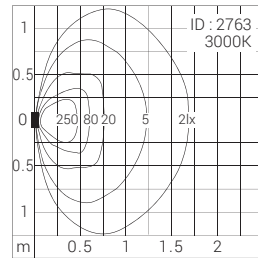

Applied Photometry : H=0.3m

Note:

- Recessed Floor Washer.
- Recommended installation height : 300 - 500 mm
- Recommended spacing : 1 metres

2750 2763

SUDO MINI - ASY VERTICAL REEDED C.O.D

2750	3W LED	76 x 87 x 130	70 x 83 x 124
2763	6W LED	76 x 87 x 255	70 x 83 x 240

2769

2770

SUDO EXTENDED - GRID / ASY C.O.D

2769 / 2770	24W LED	490 x 87 x 85	479 x 83 x 71
-------------	---------	---------------	---------------

Light Distribution

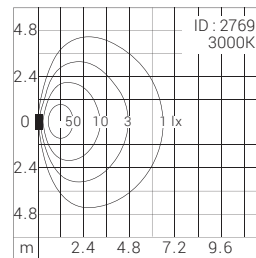

Applied Photometry : H=0.75m

Note:

- Recessed floor washer.
- Recommended installation height : 600 - 750 mm
- Recommended spacing : 4 metres

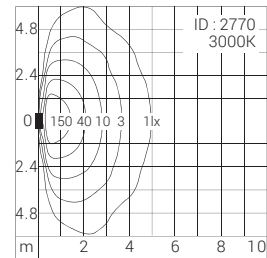

Applied Photometry : H=0.75m

Note:

- Recessed floor washer.
- Recommended installation height : 600-750 mm
- Recommended spacing : 4 metres

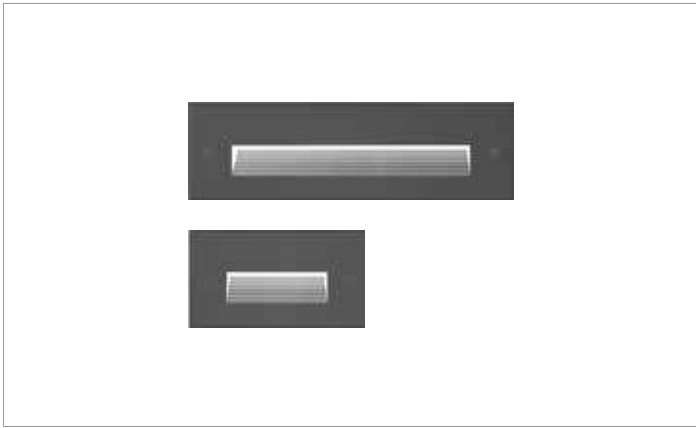

SUDO / SUDO MINI - ASY		C.O.D	
2743	12W LED	255 x 87 x 76	240 x 83 x 70
2757	6W LED	255 x 87 x 76	240 x 83 x 70
2747	6W LED	130 x 87 x 76	124 x 83 x 70

Light Distribution

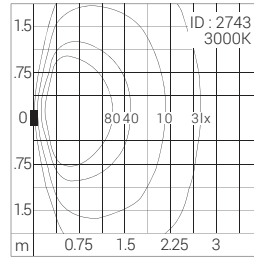

Applied Photometry : H=0.5m

- Note:
- Recessed floor washer.
 - Recommended installation height : 400 - 500 mm
 - Recommended spacing : 4 metres

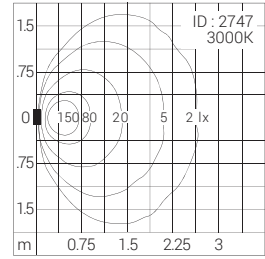

Applied Photometry : H=0.3m

- Note:
- Recessed floor washer.
 - Recommended installation height : 300 mm
 - Recommended spacing : 2 metres

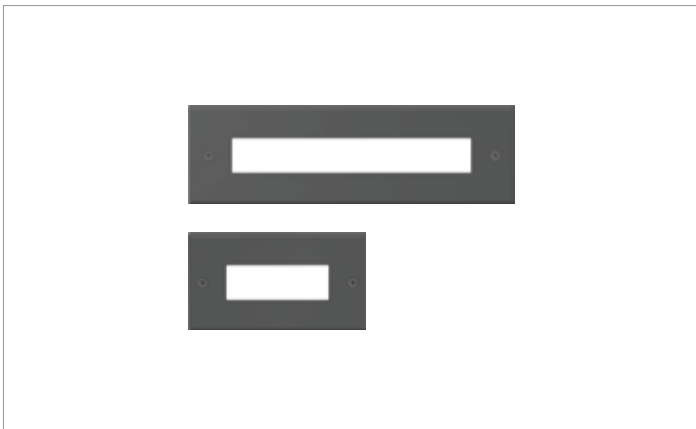

SUDO/SUDO MINI - OPEN		C.O.D	
2741	12W LED	255 x 87 x 76	240 x 83 x 70
2753	6W LED	255 x 87 x 76	240 x 83 x 70
2745	6W LED	130 x 87 x 76	124 x 83 x 70

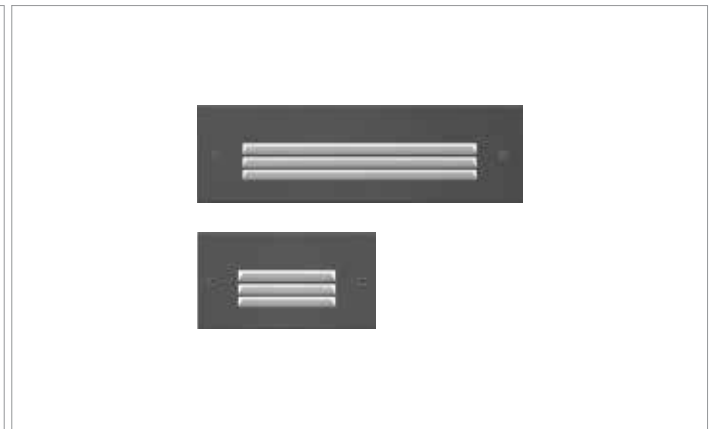

SUDO/SUDO MINI - GRID		C.O.D	
2742	12W LED	255 x 87 x 76	240 x 83 x 70
2755	6W LED	255 x 87 x 76	240 x 83 x 70
2746	6W LED	130 x 87 x 76	124 x 83 x 70

Light Distribution

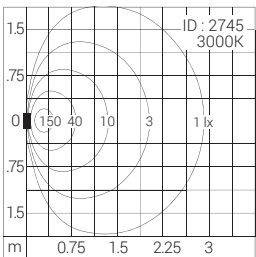

Applied Photometry : H=0.3m

- Note:
- Recessed diffused light.
 - Recommended installation height : 300 mm
 - Recommended spacing : 2 metres

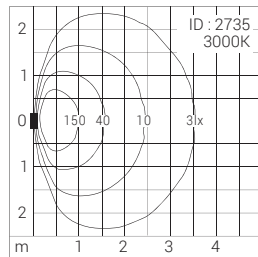

Applied Photometry : H=0.5m

- Note:
- Recessed floor washer / drive ways.
 - Recommended installation height : 500 - 800 mm
 - Recommended spacing : 3-5 metres

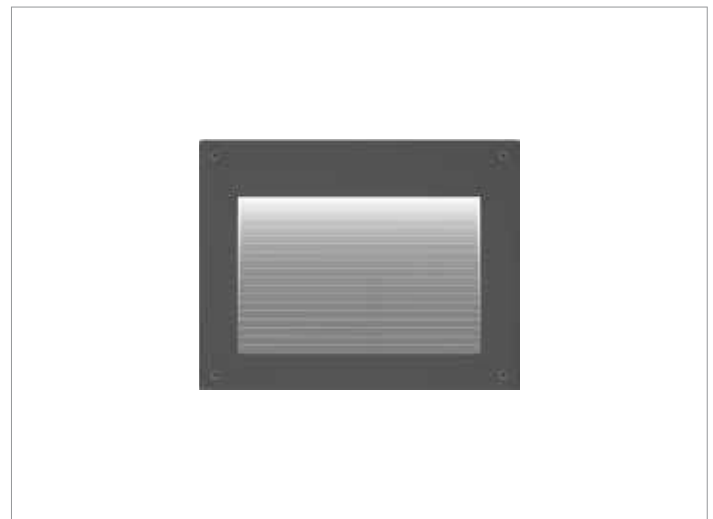

RADO		C.O.D	
2735 / 2777	12W LED / 24W LED	244 x 96 x 191	235 x 90 x 183

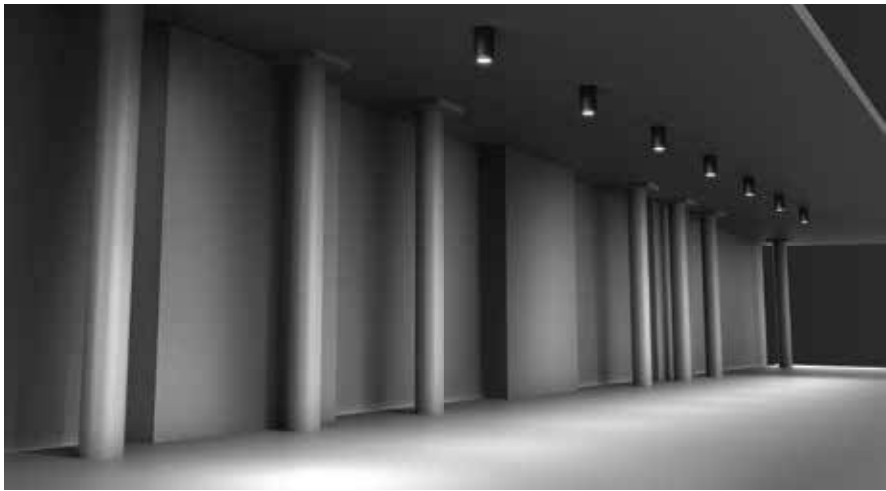

OPTICS



ACCESSORIES



HONEY COMB LOUVRE



QUAD MINI

3643	6W LED	□106 x 150
3644	12W LED	□106 x 150
3645	18W LED	□106 x 150
3632	GU10 Holder	□106 x 150



CYLIN MINI

3646	6W LED	Ø100 x 150
3647	12W LED	Ø100 x 150
4082	18W LED	Ø100 x 150
4084	GU10 Holder	Ø100 x 150



NEW

CYLIN MIDI

3629	30W LED	Ø166 x 160
------	---------	------------



CYLIN MIDI

3649	25W LED	Ø166 x 200
4083	40W LED	Ø166 x 200



CYLIN

7576	50W LED	Ø166 x 200
------	---------	------------

BA : 10° / 28° / 45°



NEW

CYLIN MEGA

3628	60W LED	Ø210 x 140
------	---------	------------

BA : 60°

Recess mounted range of LED ceiling lights are a perfect fit for varied lighting applications. The luminaires have high quality LED source with low energy consumption and long service life. Designed for low / high mounting heights. The luminaires makes them especially suitable for installation in ceiling for both interior and exterior applications. Elegantly designed fixture under the green lighting, energy efficient category.

Product Description

- Luminaire made of die-cast aluminium has excellent mechanical strength, aluminium heat sink for better thermal management.
- Reflector with excellent optical effects.
- Cable entries for through-wiring of mains supply cable.
- Integral constant current power supply
- CRI (Ra) : ≥80 (90 CRI - On Request)
- Prewired with LED driver and suitable for operating on 240V, 50Hz single phase ac supply.
- Ordering guide : KL-4241-CCT (Colour Temperature)
- Available CCT : 3000K, 4000K, 6500K



Product Benefits

- High luminous efficiency at reduced wattage.
- Elegant, Robust design
- Quick & simple installation.
- Sustainable LED technology offers durability and optimal light output with low power consumption.

Area of Application

Retail Sector, Commercial & Business Centers, Residential town ships, Educational Institutes, Hospitality & Industrial sector, Entrance foyer.

Available Finish

Pure polyester powder coated white

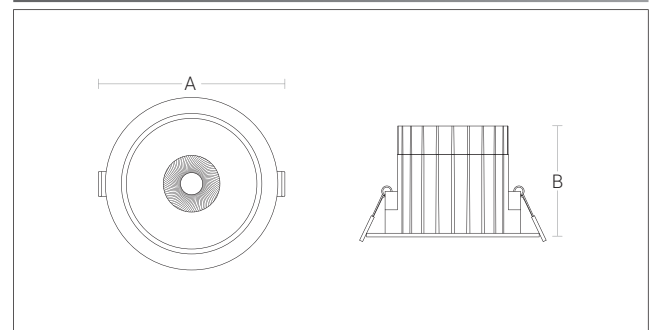

ID	Wattage	BA	A	B	Cutout
4241	10W LED	45°	Ø100	75	Ø90
4242	20W LED	45°	Ø140	90	Ø130
4243	30W LED	45°	Ø185	110	Ø155
4247	40W LED	60°	Ø230	128	Ø200

High performance robust LED recessed ceiling down light with external power supply unit for outdoor canopy installation that require IP rating. Optical options with symmetrical narrow, medium & wide beam distribution.

Product Description

- Luminaire made of die-cast aluminium alloy for better thermal management.
- Pressure die-cast aluminium outer ring.
- Clear polycarbonate optical lens
- Beam Angles : 10° / 28° / 45°
- Cable entries for through-wiring of mains supply cable.
- Luminaire supplied with fast IP67 Connectors.
- Integral constant current power supply
- CRI (Ra) : ≥80 (90 CRI - On Request)
- Prewired with LED driver and suitable for operating on 240V, 50Hz single phase ac supply.
- Ordering guide : KL-7555-CCT (Colour Temperature)
- Available CCT : 3000K, 4000K, 5700K



Product Benefits

- Quick & simple installation.
- Flexible deployment options with a wide spectrum of applications.
- Robust compact recessed downlight for exterior use.

Area of Application

Retail Sector, Commercial & Business Centers, Residential town ships, Parking lots, Educational Institutes, Hospitality & Industrial sector, Entrance foyer.

Available Finish

Pure polyester powder coated white

Photometric Data

3000K, BA10°			3000K, BA28°			3000K, BA45°		
2m	0.3m	12647 lx	2m	0.9m	2240 lx	2m	2m	911 lx
4m	0.7m	5621 lx	4m	1.8m	560 lx	4m	3.9m	228 lx
6m	1.2m	1405 lx	6m	2.7m	249 lx	6m	5.9m	101 lx
8m	1.5m	790 lx	8m	3.6m	140 lx	8m	7.8m	57lx
Height	Diameter		Height	Diameter		Height	Diameter	

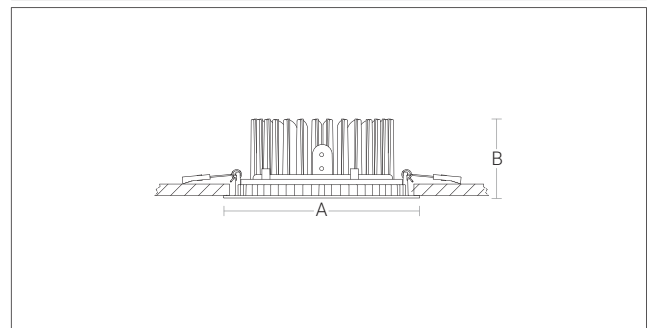

ID	Wattage	A	B	Cutout(mm)
7555	50W LED	Ø170	68	Ø160

MICRO



NEBULA MICRO



SPILL CONTROL SNOOT



ANTI-GLARE VISOR

MINI



NEBULA MINI



SPILL CONTROL SNOOT



ANTI-GLARE VISOR

MIDI



NEBULA MIDI



SPILL CONTROL SNOOT



ANTI-GLARE VISOR

NEBULA

Precise Light Minimalist Design

Stylish Nebula series is designed in such a way to provide directional spot light with various distributions.

Ideal for the illuminating landscape, architectural elements and numerous other lighting tasks in interior and exterior lighting applications.

Their sturdy construction makes them particularly suitable for areas where a high level of robustness is required.



ACCESSORIES

ANTI-GLARE VISOR



8295	Nebula Micro	Ø45x58
8306	Nebula Mini	Ø55x64
8308	Nebula Midi	Ø76x76
8310	Nebula	Ø100x79

The Push-on visor can be installed by 360° and prevents lateral glare from one direction up to 45°. The cylindrical screen has a number of openings in it that allows water to flow out if it is fixed pointing upwards.

SPILL CONTROL SNOOT



8296	Nebula Micro	Ø45x75
8307	Nebula Mini	Ø55x85
8309	Nebula Midi	Ø76x100
8323	Nebula	Ø100x125

Push-on snoot for the lateral shielding of stray light. The cylindrical screen has a number of openings in it that allows water to flow out if it is fixed pointing upwards.

HONEY COMB LOUVRE - GLARE CUT-OFF

The Internal louvre prevents a lateral glare from all directions up to 45°.



8333	Nebula Micro / Nebula Mini
8334	Nebula Midi
8335	Nebula

MOUNTING



TREE STRAP	
8275	1 metre



TREE STRAP CLAMP	
ID : 8343	

SPLIT VERSION

STANDARD VERSION

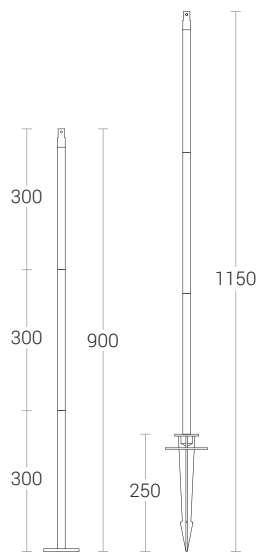
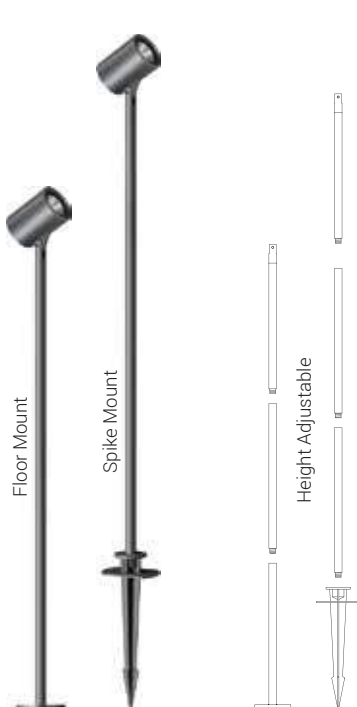

8348	Floor Mount	900
8349	Spike Mount	1150



8336	Floor Mount	700
8337	Spike Mount	990

ORDERING GUIDE

Eg : 4266 (Nebula Mini) + 8348 (Floor Mount)

Bracket will not be added when you ordering with Floor Mount / Spike Mount

Suitable for

Nebula Micro / Nebula Mini / Nebula Midi

OPTICS

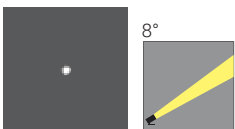

Nebula Nano / Micro
BA 8°/12°/24°/40°/60°/40°x11°

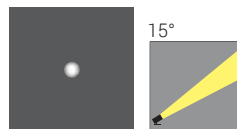

Nebula Mini / Nebula Midi / Nebula
15°/25°/40°

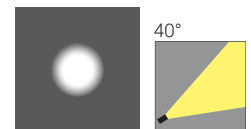
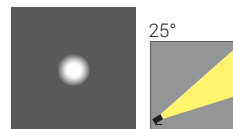

K-LITE

Garden Spot Lights



NEBULA NANO		
4276	1W LED	Ø42 x 73
4275	3W LED	Ø42 x 73

Driver for 1W Luminaire		
ID	Wattage	Driver Output
8242	1W	(3-5)V, 300mA
8243	3-5W	(8-12)V, 300mA
8244	4-8W	(12-24)V, 300mA
8245	8-12W	(24-42)V, 300mA

Driver for 3W Luminaire		
ID	Wattage	Driver Output
8246	3W	(3-5)V, 600mA
8247	9-18W	(9-25)V, 900mA
8248	21-30W	(20-36)V, 900mA

NEBULA NANO / NEBULA MICRO	
BA 8°/12°/24°/40°/60°/40°x11°	



NEBULA MICRO		
4263	3W LED	93 x 90 x 320
4264	3W LED	93 x 64 x 83



NEBULA MINI		
4265	6W LED	101 x 90 x 330
4266	6W LED	101 x 64 x 93



NEBULA MIDI		
4283	GU10 Holder	113 x 100 x 451
4284	GU10 Holder	113 x 84 x 117
4267	12W LED	113 x 100 x 451
4268	12W LED	113 x 84 x 117



NEBULA		
4269	18W LED	160 x Ø100 x 494
4270	18W LED	160 x Ø100 x 154



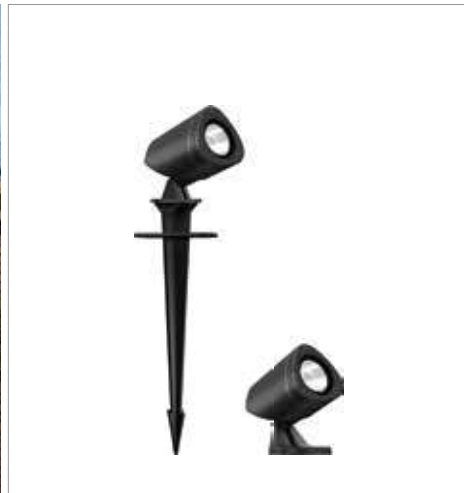

TRIOSCAPE			TRIOSCAPE		
4194	GU10 Holder	100 x 116 x 447	6998 / 7052	3W / 6W LED	BA 15°/25°/40° 100 x 116 x 447
4195	GU10 Holder	83 x 116 x 110	6988 / 7057	3W / 6W LED	83 x 116 x 110



CORVUS HYBRID
4262 12W LED Ø210 x 493



Sill creates uniform light on the outer ledge of windows creating splendid light effects. The die cast aluminium housing is ideal for better thermal management. High lumen output makes this versatile for indoor & outdoor lighting solutions.

Product Description

- Luminaire made of pressure die-cast aluminium of high corrosion resistance and non corrosive Stainless steel fasteners.
- High efficiency polycarbonate optical lens, effectively improves transmission of light.
- Clear silicone gasket for leakproof structure design to ensure the high level of IP rating.
- Cable entries for through-wiring of mains supply cable.
- Integral constant current power supply
- CRI (Ra) : ≥80 (90 CRI - On Request)
- Prewired with LED driver and suitable for operating on 240V, 50Hz single phase ac supply.
- Ordering guide : KL-3078-CCT (Colour Temperature)
- Available CCT : 3000K, 4000K, 5700K



Product Benefits

- High luminous efficiency at reduced wattage.
- Functionally versatile, strong and stable.
- Corrosion resistant and Maintenance free.
- Quick installation and low assembly costs.
- Sustainable LED technology offers durability and optimal light output with low power consumption.

Areas of Application

Window frames, historical and artistic facades, Widely used in subways, Interior decoration, Outdoor facade lighting.

Available Finish

- Pure polyester powder coated
- Graphite grey

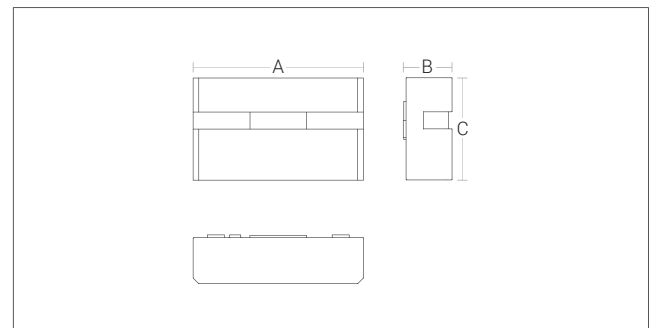
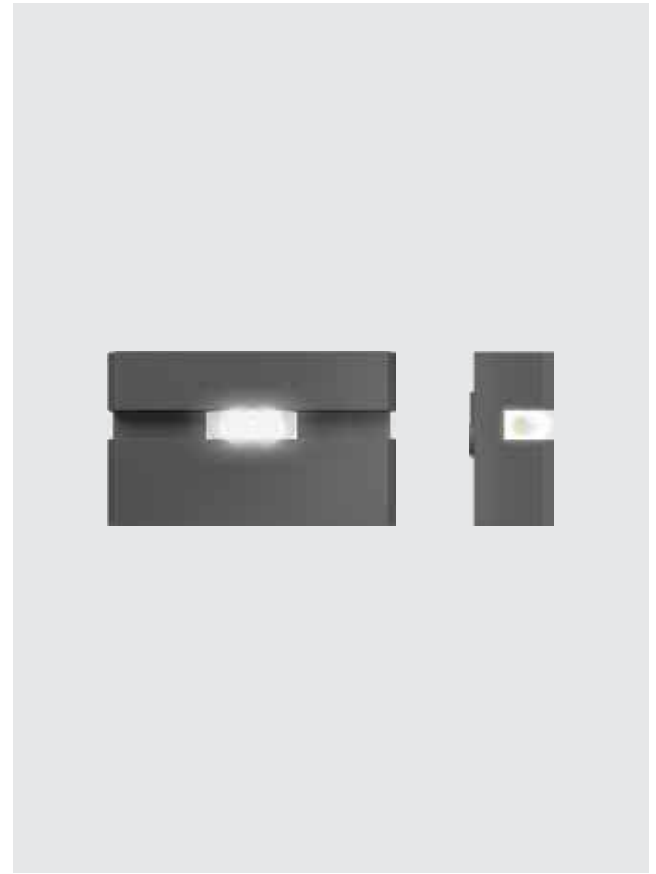

ID	Wattage	A	B	C
3078	6W LED	150	43	90

Flood Lights



NAVI SPOT		BA 6°
4285	30W LED M2	Ø166 x 153 x 423
4261	50W LED M2	Ø166 x 153 x 423



NAVI		BA 10°/28°/45°
4286	30W LED M2	Ø166 x 153 x 423
6805	50W LED M2	Ø166 x 153 x 423

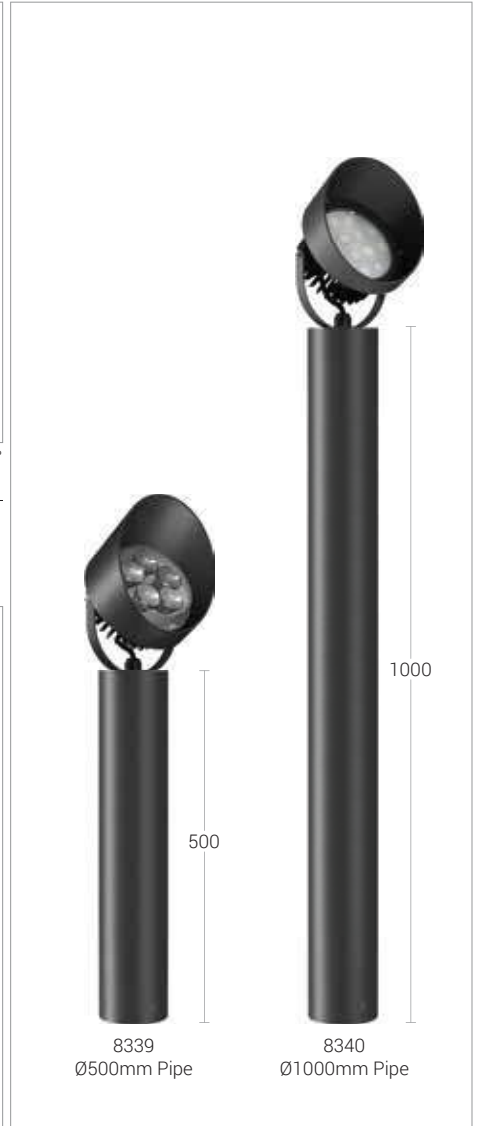

8339	Ø500mm Pipe
8340	Ø1000mm Pipe



NAVI		BA 10°/28°/45°
4287	30W LED W35	200 x Ø166 x 331
4288	50W LED W35	200 x Ø166 x 331

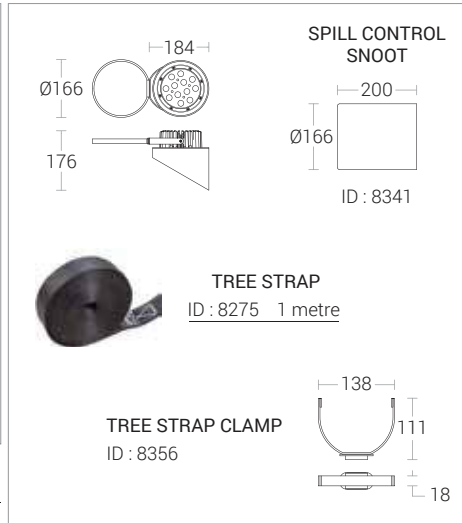

Driver for 5W Luminaire

8280	5W	(4-9)V, 700mA
8282	20W	(20-28)V, 700mA
8283	25W	(30-39)V, 750mA
8284	45W	(50-60)V, 800mA

Driver for 10W Luminaire

8281	10W	(3-6)V, 1200mA
8285	40W	(20-27)V, 1400mA
8286	60W	(28-33)V, 1800mA



CIАЗ	BA 15° / 25°
4244	5W LED Ø64 x 99
4245	10W LED Ø95 x 124

Non Integral

Aston



ASTON 1

6420 1 x 60W LED 342 x 135 x 165



ASTON 2

6789 2 x 60W LED 342 x 135 x 245



ASTON 3

6798 3 x 60W LED 342 x 135 x 325



ASTON 4

6788 4 x 60W LED 342 x 135 x 365



ASTON 6 / ASTON 8

4207 6 x 60W LED 645 x 135 x 328

4208 8 x 60W LED 645 x 135 x 368

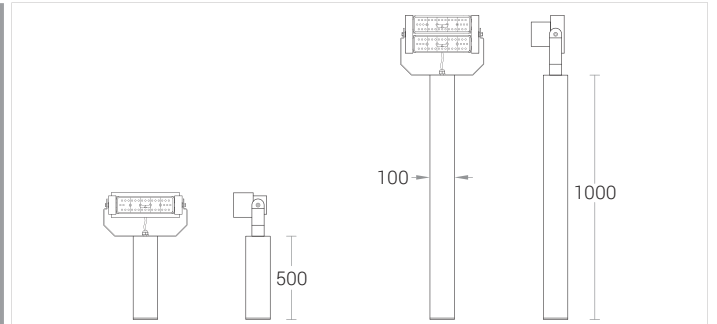

ACCESSORIES

8339

M2

Ht. 500

8340

M2

Ht. 1000

IP68 LED Module. Supplied with IP67 Driver & Connector. BA : 40° / 60°

Aston Prime



ASTON PRIME 1

4200 1 x 60W LED 342 x 135 x 165



ASTON PRIME 2

4201 2 x 60W LED 342 x 135 x 245



ASTON PRIME 3

4202 3 x 60W LED 342 x 135 x 325



ASTON PRIME 4

4203 4 x 60W LED 342 x 135 x 365

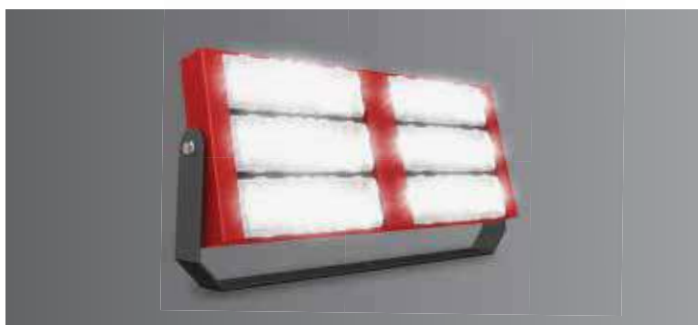

ASTON PRIME 6 / ASTON PRIME 8

4205 6 x 60W LED 645 x 135 x 328

4209 8 x 60W LED 645 x 135 x 368

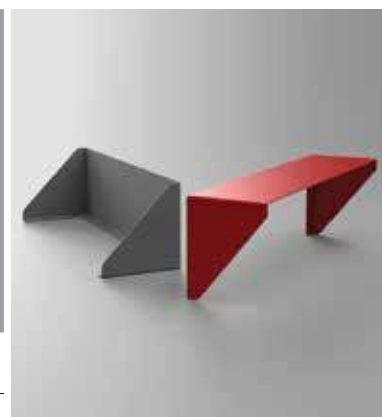

ANTI GLARE SHIELD - OPTIONAL

ID	Description
8297	Aston 1 / Aston Prime 1
8298	Aston 2 / Aston Prime 2
8299	Aston 3 / Aston Prime 3
8305	Aston 4 / Aston Prime 4

IP68 LED Module. Supplied with IP67 Driver & Connector. BA : 12° / 60°

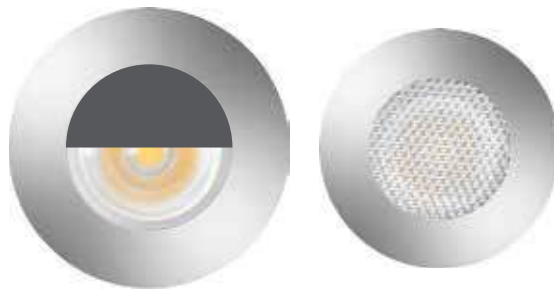

MICRO MINI

Miniature Form Versatile Application

MICROLED / MINILED is a compact IP67 LED fitting suitable for Inground, Ceiling recessed & Wall recessed for both indoor & outdoor application. Miniature form, SS body, Scratch resistance glass and special optics make these luminaires perfect for creating very defined effects of accent light. On request, these luminaires are also available in Red, Green, Blue and Amber.



K-LITE

In-Ground Luminaires

MICROLED / MINILED is a tiny IP67 LED fitting suitable for down light, wall recessed and walkover for both indoor & outdoor application. Small dimension with flush mounting installation. It is equipped with a screwless round front ring in STAINLESS STEEL with narrow beam / asymmetric beam / medium beam & diffused beam. These fixtures are perfect for creating very defined effects of accent light. On request, these luminaires are also available in Red, Green, Blue and Amber.

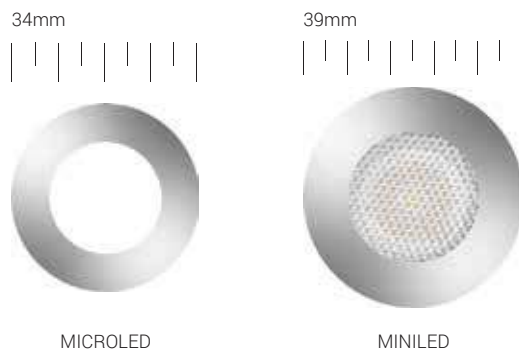

ID	Wattage	Beam Angle	Dimension
4085	1W LED	40°	Ø34 x 62
4086	3W LED	8°/12°/24°/40°/60°/40°x11°	Ø39 x 67

Non - Integral



Driver for 1W Luminaire

ID	Wattage	Driver Output
8242	1W	(3-5)V, 300mA
8243	3-5W	(8-12)V, 300mA
8244	4-8W	(12-24)V, 300mA
8245	8-12W	(24-42)V, 300mA

Driver for 3W Luminaire

ID	Wattage	Driver Output
8246	3W	(3-5)V, 600mA
8247	9-18W	(9-25)V, 900mA
8248	21-30W	(20-36)V, 900mA

Supplied with IP67 connector.
For 4085 & 4086 suitable driver to be ordered separately

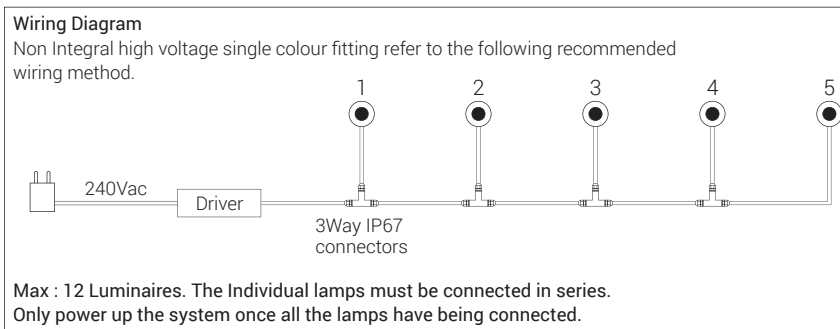

K-LITE

In-Ground Luminaires

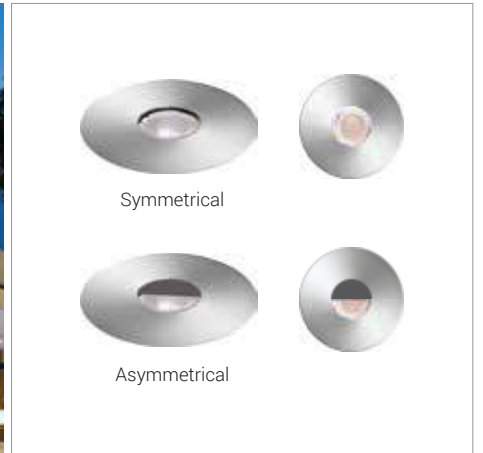

6466	Symmetrical	1W LED	Ø88 x 118
4107	Asymmetrical	1W LED	Ø88 x 118
4092	Symmetrical	3W LED	Ø88 x 118
4093	Asymmetrical	3W LED	Ø88 x 118

BA 8°/12°/24°/40°/60°/40°x11°

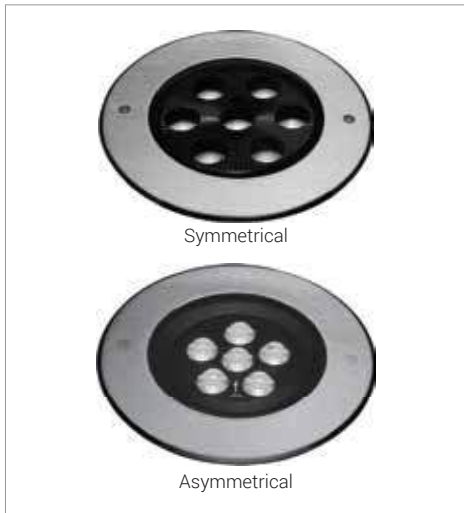

4089	Sym.	BA 40°	18W LED	Ø173 x 220
4090	Asy.	BA 35°/45°	18W LED	Ø173 x 220



4133 / 34 / 35	3W LED	Ø88 x 125
----------------	--------	-----------



4136 / 37 / 44	9W LED	Ø116 x 169
----------------	--------	------------

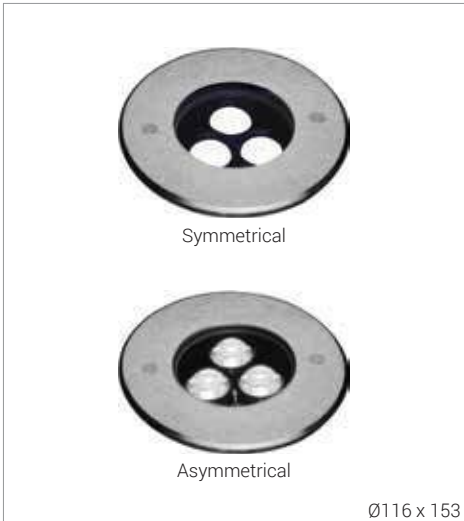

Symmetrical

Asymmetrical

Ø116 x 153

4097	Sym.	BA 8°/12°/40°/60°/40°x11°	8W LED
4098	Asy.	BA 35°/45°	8W LED



BA 15°/25°/40°

4472	Sym.Honeycomb	6W LED	Ø108 x 154
------	---------------	--------	------------



BA 15°/25°/40°

4146	Sym. Honeycomb	9W LED	Ø116 x 153
------	----------------	--------	------------



BA 15°/25°/40°

4473	Sym. Honeycomb	12W LED	Ø173 x 220
4474	Sym. Honeycomb	18W LED	Ø173 x 220
4469	Sym. Honeycomb	25W LED	Ø173 x 220



Tilttable 20°

4140	Tilttable	9W LED	Ø173 x 220
4141	Tilttable	14W LED	Ø173 x 220
4142	Tilttable	18W LED	Ø173 x 220

BA 40°



LINEAR

In-Ground

Range of linear In-Ground walk over luminaires are developed for elegant grazing light effects. These luminaires perfectly suits for building facades, pathways & wall grazing. Minimalist design and shallow recessing depth allow for discrete installation in narrow places.

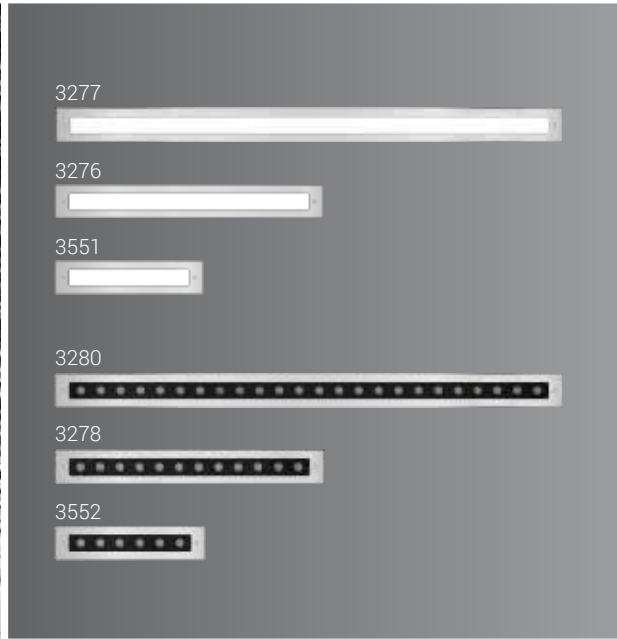
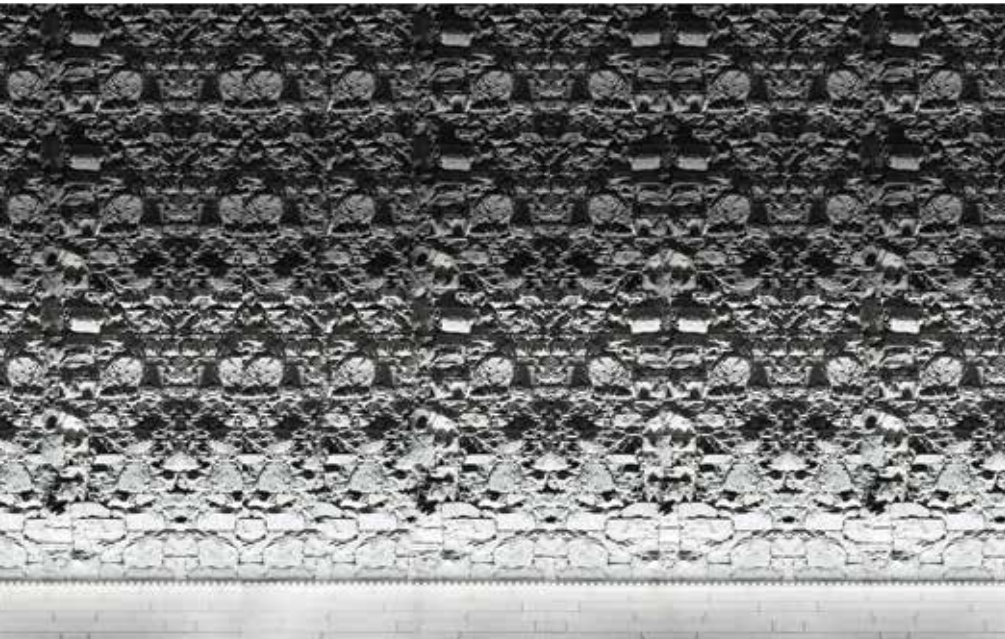

K-LITE

Linear In-Ground Luminaires

Wall Grazer

ID	Wattage	Dimension	C.O.D
3551 / 3550	6W / 12W LED	310 x 68 x 83	300 x 68 x 80
3276 / 3274	12 / 24W LED	550 x 68 x 83	540 x 68 x 80
3277 / 3275	24 / 48W LED	1025 x 68 x 83	1015 x 68 x 80

BA : 100°

Wall Washer

3552 / 3549	6W / 12W LED	310 x 68 x 83	300 x 68 x 80
3278 / 3270	12W / 24W LED	550 x 68 x 83	540 x 68 x 80
3280 / 3272	24W / 48W LED	1025 x 68 x 83	1015 x 68 x 80

BA : 8° / 28° / 40° / 64° / 12° x 53°

Luminaire to be ordered with suitable power supply.

Luminaire operating voltage is 24Vdc. Supplied with IP67 connector.

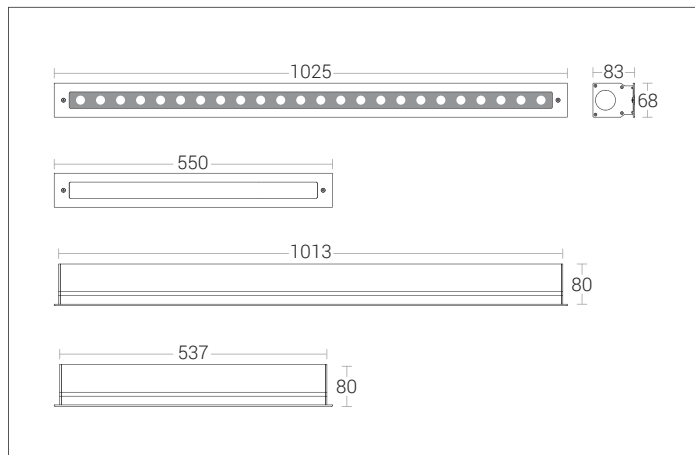

Luminaire supplied with honeycomb louvre



Optional



ID : 8330 - Longitudinal Louvre



K-LITE

Linear Wall Washers

ID	Wattage	A	B	C
3092	12W LED WW / CW	500	35	78
3094	24W LED WW / CW	1000	35	78
3068	36W LED WW / CW	1000	35	78
3070	36W LED RGB	1000	35	78
3066	72W LED WW / CW	1000	48	118
3067	72W LED RGB	1000	48	118

Luminaire to be ordered with suitable power supply and RGB controller.
 Luminaire operating voltage is 24Vdc. **BA : 30° / 15°x60°**



8276 IP67 End Cap Connector Socket 8277 IP67 Interconnection cable - 1M with Connector 8278 M/F connector for power supply (0.5M cable)

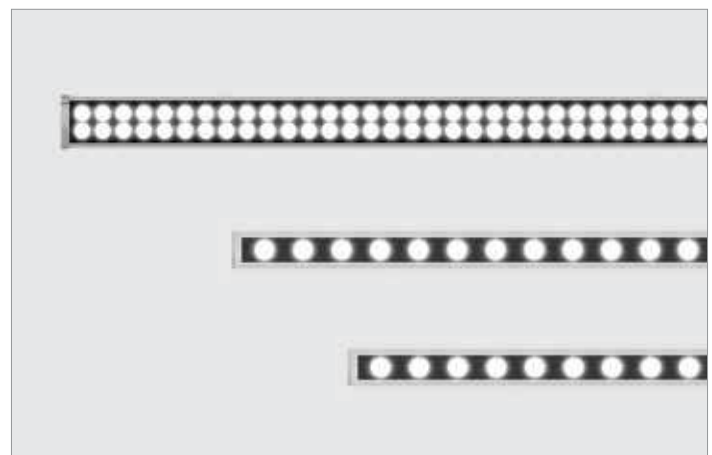
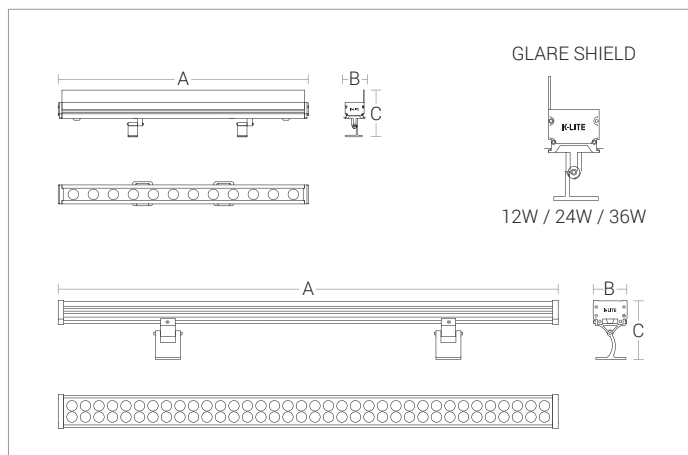



K-LITE

Linear Wall Washers

ID	Wattage	A	B	C
3553	6W LED WW / CW	300	34	52
3554	12W LED WW / CW	500	34	52
3555	24W LED WW / CW	1000	34	52

Luminaire to be ordered with suitable power supply.
 Luminaire operating voltage is 24Vdc. BA : 15° / 35° / 15°x50°

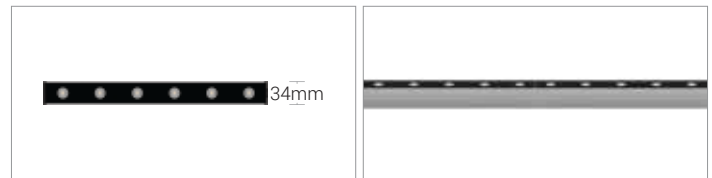

Compact Size

Installation in continual line



8319

8322

8320 / 8321

IP67 End Cap Connector Socket

IP67 Interconnection cable
- 1M with Connector

M/F connector for power supply
(0.5M cable)

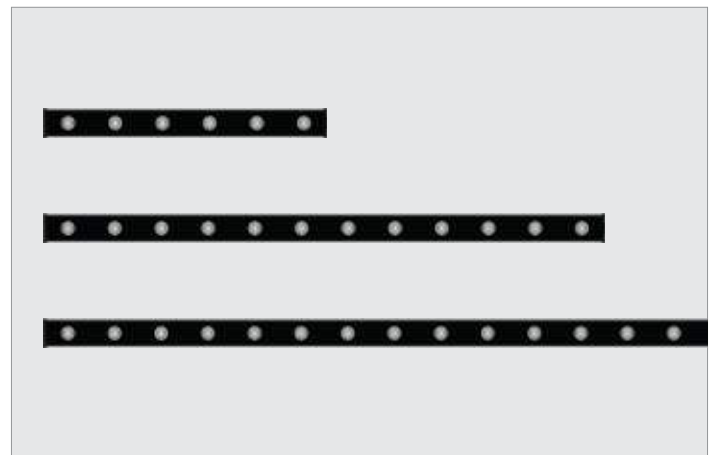
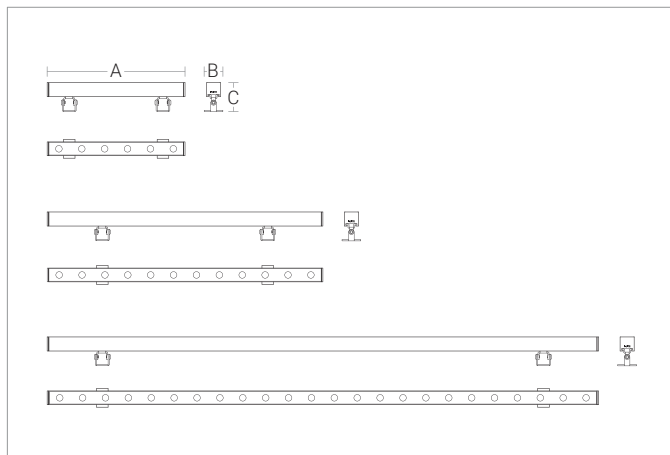



9 WATTS LED NEON FLEX 24Vdc

ID	LED	Size (mm)	Colour	Cut Length	LED's per Metre	IP65 Packing
3230	2835	9.4 x 15	WW	0.5m	120 pcs	50m/roll



ACCESSORIES KIT

Inter Connector	Pin	End Cap	ID	Accessories
			8179	Font 0.25m Power cord
			8180	1m Aluminium Profile
			8257	Fixing Aluminium clip 50mm
			8258	Pins (10 Nos)
			8259	Inter Connector

Luminaire to be ordered with suitable power supply.

Tango Flex



24V DC 2835 FLEXIBLE WALL WASHER

ID	Wattage	Size (mm)	Colour	LED's per Metre	IP67 Packing
3240	10W/m	26 x 12	WW (2700K)	42 pcs	2m/roll

Luminaire to be ordered with suitable power supply.

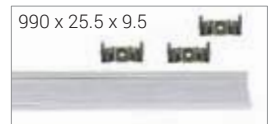

ID : 8359 Aluminium U Channel with Clamp

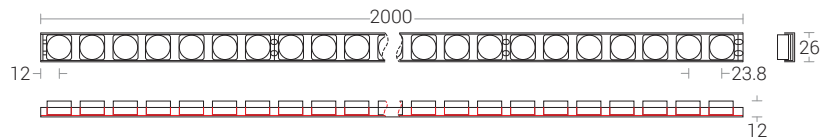



24Vdc 2835 Flexible LED Strip

ID	Wattage	LED's per m	Cut. length	Packing
3527	20W/m	168 pcs	36mm	5m / Roll

24Vdc 5050 Flexible LED Strip - RGBW

ID	Wattage	LED's per m	Cut. length	Packing
3528	20W/m	84 pcs	100mm	5m / Roll



ID : 3527



ID : 3528

ACCESSORIES KIT - MOUNTING



20 x 18.8 x 17.8

ID : 8362
Aluminium Clip



17.8 x 16.3 x upto 50m

ID : 8363
Flexible 304 SS Channel

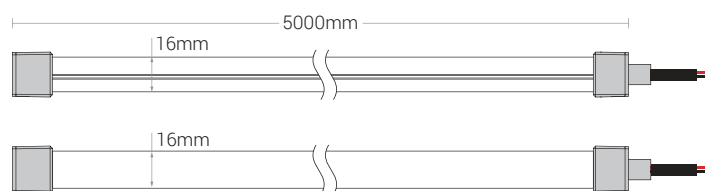



LEMONTREE HOTEL, UDAIPUR

Recessed Pool LED Luminaires



4105 4 x 2W LED WW Ø135 x 74



6700 6 x 2W LED WW Ø180 x 78
6707 6 x 3W LED RGB Ø180 x 78



4109 12 x 2W LED WW Ø205 x 76



Surface Mounted LED Spot Light



6740 1 x 3W LED WW 106x70x134
4116 1 x 3W LED RGB 106x70x134



4131 3 x 2W LED WW Ø95x106x150



4132 6x3W LED WW Ø127x120x193

LED Fountain Light



Suitable for G(PF)3/4
4129 9 x 2W LED WW Ø150 x 62
4130 9 x 2W LED RGB Ø150 x 62



4127 6 x 2W LED WW 166 x 33

Luminaire operating voltage is 12/24Vdc. Luminaire to be ordered with suitable power supply and RGB controller.

K-LITE

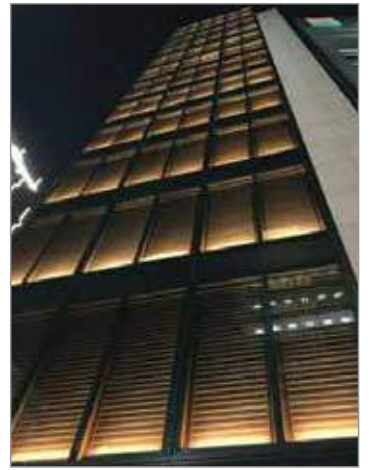

IP67 ARCHITECTURAL LINEARS

ENCAPSULATED SERIES 2023





Open Source

LINEAR IP67

Minimalistic,
yet impressive

Powerful, versatile, robust, linear encapsulation series provides a reliable long-term lighting solution.

These IP67 waterproof linear lights are perfectly suited for exterior facade, edge lighting and many more applications.

IP67 linear LED lights are manufactured with the highest quality materials and is integrated with current stabilization system. Encapsulated aluminium housing is UV resistant and can be maintained with ease. Available in various lengths, profiles to suit a variety of applications.

Our IP67 profiles are modular and offers an innovative lighting solution in constrained space which require linear lighting. The profiles are made of extruded aluminium and are available in powder coated white / black and anodised aluminium finish options. Depending upon form selected clear and translucent encapsulation options are available. The aluminium profile and the polyurethane encapsulation lends to IP67 protection class. Various mounting options are available making it a versatile product for various applications.

Product Features

- Luminaire made of extruded aluminium for better thermal management.
- Clear / Translucent polyurethane encapsulation.
- Surface / Recessed / Suspended mounting options available.
- IP67 connector on both ends and can be easily installed via mounting clips or adjustable wall clamps.
- Constant voltage LED driver 24V Non integral (to be ordered separately)
- MacAdam LEDs \leq 3-step
- High CRI80+, CRI90+ LEDs
- Dimmable
- Special colour on request (Red, Green, Blue, Amber etc.)
- Multiple lengths available



Area of Application

Hotel & Resorts, Staircase Lighting, Malls, Restaurants, Receptions, Shopping Complex, Commercial & Business Centers, Residential Lighting and similar applications.

Installation Note

- Surface, Recessed or Suspended
- Based on site requirement can be glued using PU glue, silicone / grouted or plastered in on-site cutouts.
- Mounting accessories : Wall clamps / Clips / Suspension kits as per site requirement
- Luminaire to be ordered with suitable 24V dc power supply.
- Mounting tray for better cable management with slide fit system.

Voltage drop information for the feed-in-line (PSU / Control to fixture)

STATIC COLOUR			Max.cable length
Power (m)	Cable spec	Product run length	PSU-luminaire
10W/m	.34 mm ² / AWG 22	1m / 2m	19m / 10m
20W/m	.34 mm ² / AWG 22	1m / 2m	7m / 3.5m
RGBW			
20W/m	.34 mm ² / AWG 22	1m / 2m	10m / 4.5m
40W/m	.34 mm ² / AWG 22	1m / 2m	4.5m / --

Note : Calculation is based on a max. voltage drop of 0.80V and is based on the cable configuration on-site.

Important Note:

- The given data are standard values. Due to tolerances of the manufacturing process and the electrical components, photometric values and electrical power can vary up to 10 - 12%.
- Luminous flux upto -40% with opal transmission.
- In IP67 encapsulated products, tolerance in colour temperature can occur.
- Light distribution refer online

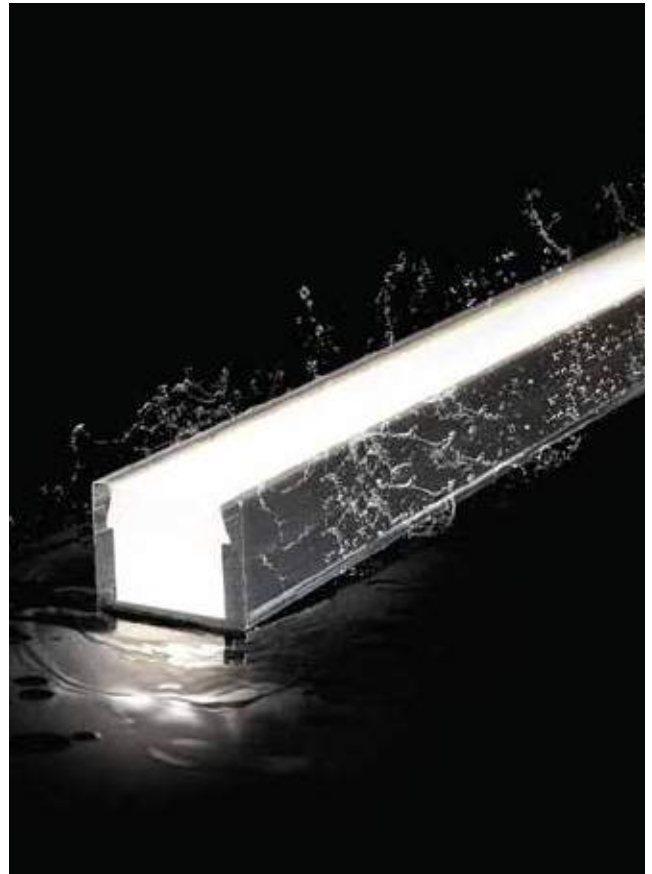

Open Source



K-LITE

Form-17, Mono / RGBW

Power : 5W/10W 10W/20W 15W/30W 20W/40W
 Length : 510mm 1010mm 1510mm 2010mm

Features

- Small form factor
- LUMILEDS LED's
- CRI Ra>80 (>90 on request)
- SDCM ≤ 3
- L80 / B10 @ 60,000 Hrs
- For ready use with IP67 connectors
- Encapsulated linear luminaire
- IP67 protection class

Options

- CCT : 2700K / 3000K / 4000K / RGBW
(Special colour on request)
- Driver options



Accessories

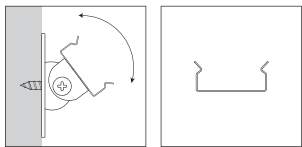

Adjustable wall clamp

Surface mounting clip

Surface mounting clip / Adjustable clip recommended to use every 500mm

Cabling Accessories



Lead connector

Extension cable

End cap

ID	Description	Dimension (mm)
8317	Clip	19 x 19 x 7.5
8318	Adjustable clip	24 x 36 x 20
8319	End cap	-
8320/8321	Male / Female connector	0.5m Cable
8322	Extension cable	1m Cable

* Fixture manufactured to desired length with multiples of 500mm (not to be cut at site)

* Driver and mounting accessories to be ordered separately



Mono colour

RGBW

Dimension in mm



Ceiling surface mounting

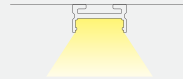

Floor surface mounting

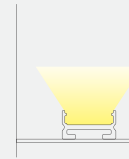

Housing Colour



High-quality aluminium with powder coated finish in RAL9005 Black fine texture | RAL9016 White fine texture



Open Source

Light Distribution refer online

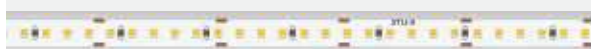



Technical Specifications

Light Source

Light Source	: LUMILEDS
CRI (Ra)	: >80 (>90 on request)
LED Colour Temperature	: 2700K / 3000K / 4000K / RGBW (Special colours on request)

General

Driver	: Constant Voltage
Input Voltage	: 220-240Vac
Operating Temperature	: -15°C~+50°C
Operating Voltage	: 24Vdc
Power Supply	: Non Integral 24V PSU (IP67)

Optical

Tilt	: Fixed
Beam Angle	: 120° (pixelated)
Diffuser Material	: Clear Polyurethane Encapsulation

Physical

Body	: Extruded Aluminium with Translucent Endcaps
Mounting	: Surface / Tiltable
Finish	: White / Black

Specification

Power (W/m)	10W/m	20W/m
Max.length (m)	2 mts	2 mts
Max.serial run length (m)	5 mts	3 mts
Max.ambient temp.(T _{max})	50°C	45°C

- The given data are standard values. Due to tolerances of the manufacturing process and the electrical components, photometric values and electrical power can vary up to 10 - 12%.
- Luminous flux upto -40% with opal transmission.
- In IP67 encapsulated products, tolerance in colour temperature can occur.
- Light distribution refer online



Ordering Guide

Surface - Mono

ID	Wattage	Dimension (mm)
3265	5W	510 x 17 x 9
3256	10W	1010 x 17 x 9
3266	15W	1510 x 17 x 9
3267	20W	2010 x 17 x 9

Surface - RGBW

ID	Wattage	Dimension (mm)
3615	10W	510 x 17 x 9
3616	20W	1010 x 17 x 9
3617	30W	1510 x 17 x 9
3618	40W	2010 x 17 x 9

* Voltage drop information refer to page no: 67

K-LITE

Form-16

Power : 5W 10W 15W 20W
 Length : 500mm 1000mm 1500mm 2000mm

Features

- Small form factor
- LUMILEDS LED's
- CRI Ra>80 (>90 on request)
- SDCM ≤ 3
- L80 / B10 @ 60,000 Hrs
- For ready use with IP67 connectors
- Encapsulated linear luminaire
- IP67 protection class
- Mounting tray for better cable management with slide fit system.

Options

- CCT : 2700K / 3000K / 4000K
(Special colour on request)
- Driver options



Accessories

Cabling Accessories



Lead connector Extension cable End cap

ID	Description	Dimension (mm)
8319	End cap	-
8320/8321	Male / Female connector	0.5m Cable
8322	Extension cable	1m Cable

* Fixture manufactured to desired length with multiples of 500mm (not to be cut at site)

* Driver and mounting accessories to be ordered separately



Dimension in mm

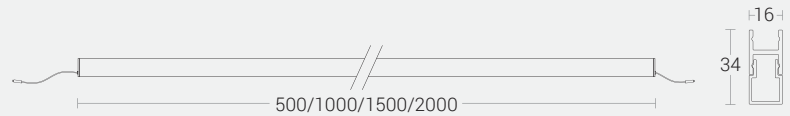

Ceiling mounting

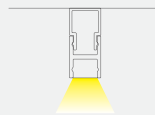

Floor mounting

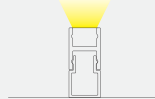

Vertical surface mounting

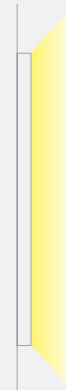

Housing Colour



High-quality aluminium with powder coated finish in RAL9005 Black fine texture | RAL9016 White fine texture | Anodised Aluminium



Open Source

Light Distribution refer online

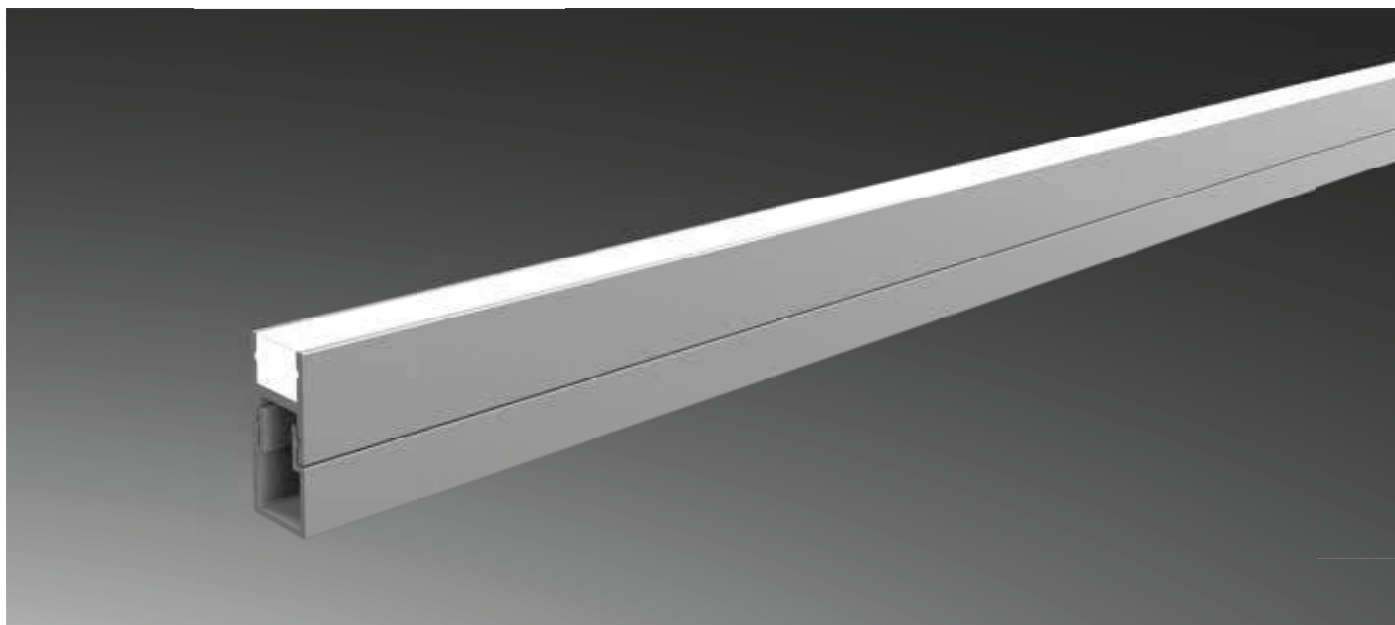

Technical Specifications

Light Source

Light Source	: LUMILEDS
CRI (Ra)	: >80 (>90 on request)
LED Colour Temperature	: 2700K / 3000K / 4000K (Special colours on request)

General

Driver	: Constant Voltage
Input Voltage	: 220-240Vac
Operating Temperature	: -15°C~+50°C
Operating Voltage	: 24Vdc
Power Supply	: Non Integral 24V PSU (IP67)

Optical

Tilt	: Fixed
Beam Angle	: 120° (Diffused)
Diffuser Material	: Translucent Polyurethane Encapsulation

Physical

Body	: Extruded Aluminium
Mounting	: Surface
Finish	: White / Black / Anodized Aluminium

Specification

Power (W/m)	10W/m
Max.length (m)	2 mts
Max.serial run length (m)	5 mts
Max.ambient temp.(Ta _{max})	50°C

- The given data are standard values. Due to tolerances of the manufacturing process and the electrical components, photometric values and electrical power can vary up to 10 - 12%.
- Luminous flux upto -40% with opal transmission.
- In IP67 encapsulated products, tolerance in colour temperature can occur.
- Light distribution refer online



Ordering Guide

Surface - Direct

ID	Wattage	Dimension (mm)
3247	5W	500 x 16 x 34
3251	10W	1000 x 16 x 34
3569	15W	1500 x 16 x 34
3570	20W	2000 x 16 x 34

* Voltage drop information refer to page no: 67

K-LITE

Form-26

Power : 10W 20W 30W 40W
 Length : 500mm 1000mm 1500mm 2000mm

Features

- Small form factor
- LUMILEDS LED's
- CRI Ra>80 (>90 on request)
- SDCM \leq 3
- L80 / B10 @ 60,000 Hrs
- For ready use with IP67 connectors
- Encapsulated linear luminaire
- IP67 protection class
- Mounting tray for better cable management with slide fit system.

Options

- CCT : 2700K / 3000K / 4000K
(Special colour on request)
- Driver options



Dimension in mm

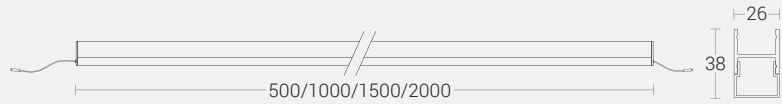

Ceiling mounting

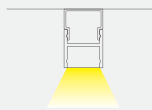

Floor mounting

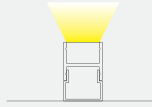

Vertical surface mounting

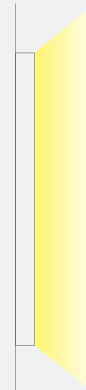

Housing Colour



High-quality aluminium with powder coated finish in
 RAL9005 Black fine texture | RAL9016 White fine texture |
 Anodised Aluminium

Accessories

Cabling Accessories



Lead connector

Extension cable

End cap

ID	Description	Dimension (mm)
8319	End cap	-
8320/8321	Male / Female connector	0.5m Cable
8322	Extension cable	1m Cable

* Fixture manufactured to desired length with multiples of 500mm (not to be cut at site)

* Driver and mounting accessories to be ordered separately



Open Source

Light Distribution refer online

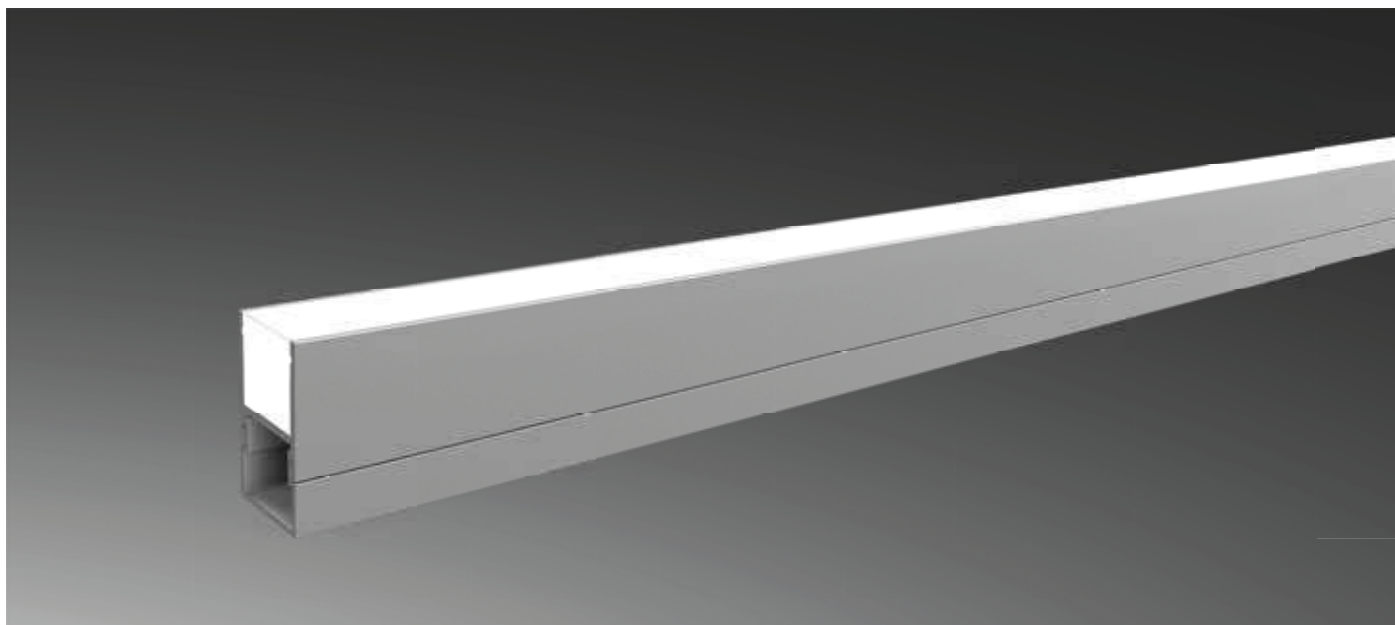

Technical Specifications

Light Source

Light Source	: LUMILEDS
CRI (Ra)	: >80 (>90 on request)
LED Colour Temperature	: 2700K / 3000K / 4000K (Special colours on request)

General

Driver	: Constant Voltage
Input Voltage	: 220-240Vac
Operating Temperature	: -15°C~+50°C
Operating Voltage	: 24Vdc
Power Supply	: Non Integral 24V PSU (IP67)

Optical

Tilt	: Fixed
Beam Angle	: 120° (Diffused)
Diffuser Material	: Translucent Polyurethane Encapsulation

Physical

Body	: Extruded Aluminium
Mounting	: Surface
Finish	: White / Black / Anodized Aluminium

Specification

Power (W/m)	10W/m	20W/m
Max.length (m)	2 mts	2 mts
Max.serial run length (m)	5 mts	3 mts
Max.ambient temp.(Ta _{max})	50°C	45°C

- The given data are standard values. Due to tolerances of the manufacturing process and the electrical components, photometric values and electrical power can vary up to 10 - 12%.
- Luminous flux upto -40% with opal transmission.
- In IP67 encapsulated products, tolerance in colour temperature can occur.
- Light distribution refer online



Ordering Guide

Surface - Direct

ID	Wattage	Dimension (mm)
3245	10W	500 x 26 x 38
3254	20W	1000 x 26 x 38
3571	30W	1500 x 26 x 38
3572	40W	2000 x 26 x 38

* Voltage drop information refer to page no: 67

K-LITE

In-Form-33 Slim

Power : 10W 20W 30W 40W
 Length : 500mm 1000mm 1500mm 2000mm

Features

- Small form factor
- LUMILEDS LED's
- CRI Ra>80 (>90 on request)
- SDCM ≤ 3
- L80 / B10 @ 60,000 Hrs
- For ready use with IP67 connectors
- Encapsulated linear luminaire
- IP67 protection class
- Mounting tray for better cable management with slide fit system.

Options

- CCT : 2700K / 3000K / 4000K
(Special colour on request)
- Driver options



Dimension in mm

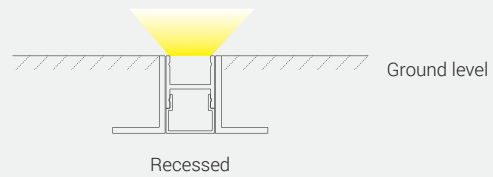
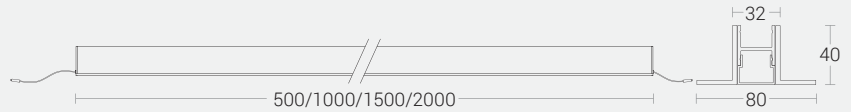

Housing Colour

- Stainless steel

Accessories

Cabling Accessories



Lead connector Extension cable End cap

ID	Description	Dimension (mm)
8319	End cap	-
8320/8321	Male / Female connector	0.5m Cable
8322	Extension cable	1m Cable

- * Fixture manufactured to desired length with multiples of 500mm (not to be cut at site)
- * Driver and mounting accessories to be ordered separately

Light Distribution refer online

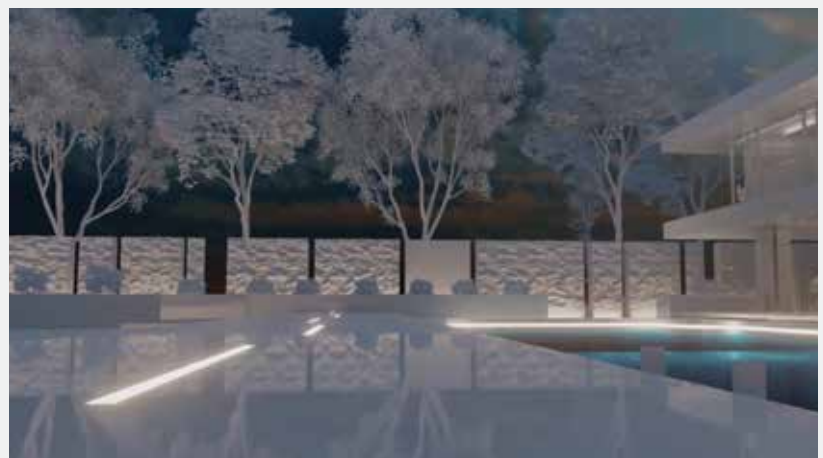

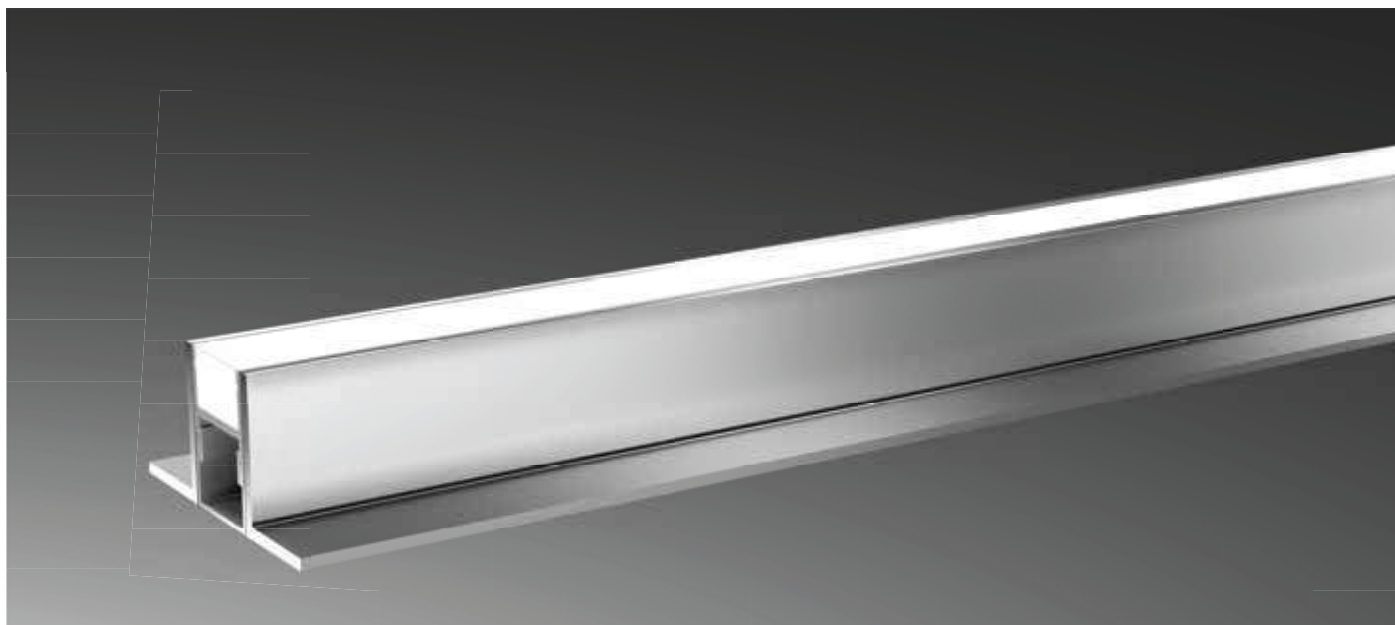

Technical Specifications

Light Source

Light Source	: LUMILEDS
CRI (Ra)	: >80 (>90 on request)
LED Colour Temperature	: 2700K / 3000K / 4000K (Special colours on request)

General

Driver	: Constant Voltage
Input Voltage	: 220-240Vac
Operating Temperature	: -15°C~+50°C
Operating Voltage	: 24Vdc
Power Supply	: Non Integral 24V PSU (IP67)

Optical

Tilt	: Fixed
Beam Angle	: 120°
Diffuser Material	: Translucent Polyurethane Encapsulation

Physical

Body	: Stainless Steel
Mounting	: Recess

Specification

Power (W/m)	10W/m	20W/m
Max.length (m)	2 mts	2 mts
Max.serial run length (m)	5 mts	3 mts
Max.ambient temp.(Ta _{max})	50°C	45°C

- The given data are standard values. Due to tolerances of the manufacturing process and the electrical components, photometric values and electrical power can vary up to 10 - 12%.
- Luminous flux upto -40% with opal transmission.
- In IP67 encapsulated products, tolerance in colour temperature can occur.
- Light distribution refer online



Ordering Guide

Recess

ID	Wattage	Dimension (mm)
3621	10W	500 x 80 x 40
3622	20W	1000 x 80 x 40
3623	30W	1500 x 80 x 40
3624	40W	2000 x 80 x 40

* Voltage drop information refer to page no: 67

K-LITE

Cedar-60

Power : 10W 20W 40W
 Length : 520mm 1020mm 2020mm

Features

- Small form factor
- LUMILEDS LED's
- CRI Ra>80 (>90 on request)
- SDCM ≤ 3
- L80 / B10 @ 60,000 Hrs
- For ready use with IP67 connectors
- Encapsulated linear luminaire
- IP67 protection class
- Surface mounting clip recommended to use every 500mm

Options

- CCT : 2700K / 3000K / 4000K
(Special colour on request)
- Driver options



Accessories

Cabling Accessories



Lead connector

ID	Description	Dimension (mm)
8320/8321	Male / Female connector	0.5m Cable

* Fixture manufactured to desired length with multiples of 500mm (not to be cut at site)

* Driver and mounting accessories to be ordered separately



Dimension in mm

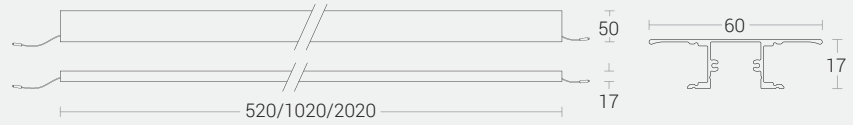

Wall mounting

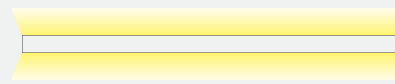

Housing Colour



High-quality aluminium with powder coated finish in RAL9005 Black fine texture | RAL9016 White fine texture | Gold fine texture



Light Distribution refer online



Technical Specifications

Light Source

Light Source	: LUMILEDS
CRI (Ra)	: >80 (>90 on request)
LED Colour Temperature	: 2700K / 3000K / 4000K (Special colours on request)

Physical

Body	: Extruded Aluminium with Translucent Endcaps
Mounting	: Surface
Finish	: White / Black / Gold

General

Driver	: Constant Voltage
Input Voltage	: 220-240Vac
Operating Temperature	: -15°C~+50°C
Operating Voltage	: 24Vdc
Power Supply	: Non Integral 24V PSU (IP67)

Specification

Power (W/m)	20W/m
Max.length (m)	2 mts
Max.serial run length (m)	3 mts
Max.ambient temp.(Ta _{max})	45°C

Optical

Tilt	: Fixed
Beam Angle	: 60° (Pixelated)
Diffuser Material	: Clear Polyurethane Encapsulation

- The given data are standard values. Due to tolerances of the manufacturing process and the electrical components, photometric values and electrical power can vary up to 10 - 12%.
- Luminous flux upto -40% with opal transmission.
- In IP67 encapsulated products, tolerance in colour temperature can occur.
- Light distribution refer online



Ordering Guide

Surface

ID	Wattage	Dimension (mm)
3585	10W	520 x 60 x 17
3619	20W	1020 x 60 x 17
3620	40W	2020 x 60 x 17

* Voltage drop information refer to page no: 67

K-LITE

Power Grazer-32, Mono / RGBW

Power : 10W 20W 30W 40W
 Length : 505mm 1005mm 1505mm 2005mm

Features

- Perfectly solution for wall grazing
- Small form factor
- LUMILEDS LED's
- CRI Ra>80 (>90 on request)
- SDCM ≤ 3
- L80 / B10 @ 60,000 Hrs
- For ready use with IP67 connectors
- Encapsulated linear luminaire
- IP67 protection class

Options

- CCT : Amber / 2700K / 3000K / 4000K / RGBW (Special colour on request)
- Driver options



Accessories

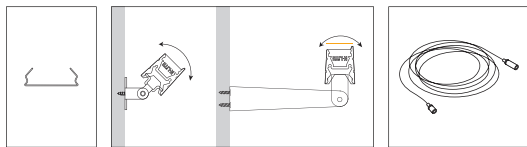

Surface mounting clip Adjustable wall clamp Suspension kit

Surface mounting clip recommended to use every 500mm / Adjustable stainless steel suspension kit (1 metre) available on request / Adjustable wall clamp recommended to use for every 900mm.

Cabling Accessories



Lead connector Extension cable End cap

ID	Description	Dimension (mm)
8317	Clip	19 x 19 x 7.5
8331	Adjustable wall clamp	-
8293	Suspension kit set	1m
8319	End cap	-
8320/8321	Male / Female connector	0.5m Cable
8322	Extension cable	1m Cable

* Fixture manufactured to desired length with multiples of 500mm (not to be cut at site)

* Driver and mounting accessories to be ordered separately



Mono colour

RGBW

Dimension in mm

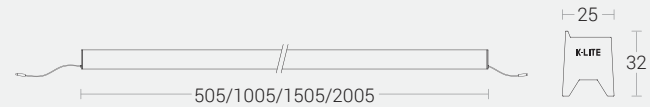

Wall mounting

Ceiling mounting

Suspension mounting

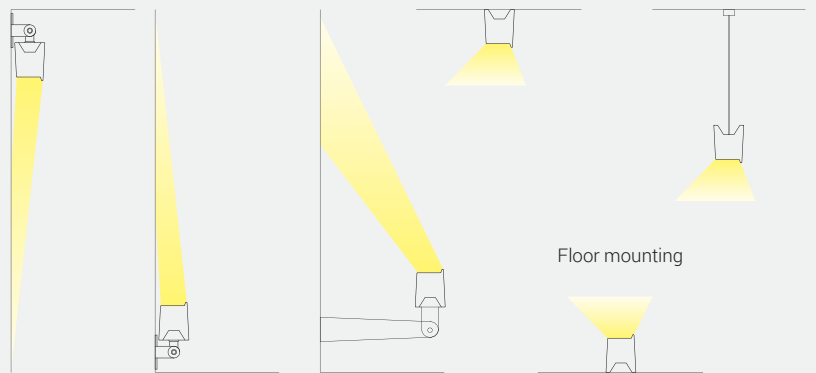

Floor mounting

Housing Colour



High-quality aluminium with powder coated finish in RAL9005 Black fine texture | RAL9016 White fine texture



Open Source

Light Distribution refer online

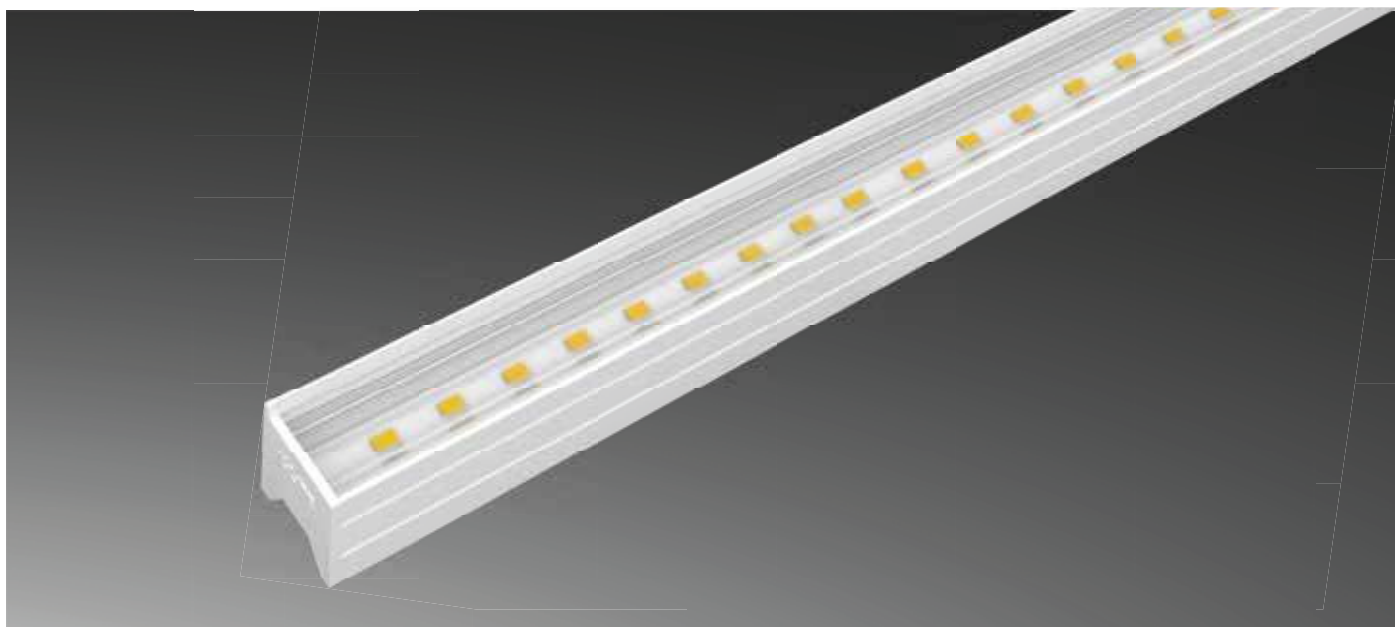

Technical Specifications

Light Source

Light Source	: LUMILEDS
CRI (Ra)	: >80 (>90 on request)
LED Colour Temperature	: Amber / 2700K / 3000K / 4000K / RGBW (Special colours on request)

General

Driver	: Constant Voltage
Input Voltage	: 220-240Vac
Operating Temperature	: -15°C~+50°C
Operating Voltage	: 24Vdc
Power Supply	: Non Integral 24V PSU (IP67)

Optical

Efficiency (lm/w)	: 20W : >60 / 40W : >45 (RGBW)
Tilt	: Fixed
Beam Angle	: 30° / 60°
Luminaire Efficiency	: Upto 70 lm/W (Mono)
Diffuser Material	: Clear Polyurethane Encapsulation

Physical

Body	: Extruded Aluminium with Translucent Endcaps
Mounting	: Surface / Tilttable
Finish	: White / Black

Specification

Power (W/m)	20W/m	40W/m
Max.length (m)	2 mts	2 mts
Max.serial run length (m)	3 mts	2 mts
Max.ambient temp.(Ta _{max})	45°C	45°C

- The given data are standard values. Due to tolerances of the manufacturing process and the electrical components, photometric values and electrical power can vary up to 10 - 12%.
- Luminous flux upto -40% with opal transmission.
- In IP67 encapsulated products, tolerance in colour temperature can occur.
- Transparent end caps also available.
- Light distribution refer online



Ordering Guide

Surface - Direct

ID	Wattage	Dimension (mm)	ID	Wattage	Dimension (mm)
3556	10W	505 x 25 x 32	3560	10W	505 x 25 x 32
3557	20W	1005 x 25 x 32	3561	20W	1005 x 25 x 32
3558	30W	1505 x 25 x 32	3562	30W	1505 x 25 x 32
3559	40W	2005 x 25 x 32	3563	40W	2005 x 25 x 32

RGBW

* Voltage drop information refer to page no: 67

K-LITE

Aster-6, Flexible

Power : 5W 10W 15W 20W
Length: 510mm 1010mm 1510mm 2010mm

Features

- LUMILEDS LED's
- CRI Ra>80 (>90 on request)
- SDCM ≤ 3
- L80 / B10 @ 60,000 Hrs
- For ready use with IP67 connectors
- Encapsulated linear luminaire
- IP67 protection class

Options

- CCT : 2700K / 3000K / 4000K
(Special colour on request)
- Driver options

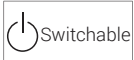

Dimension in mm

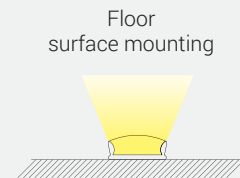
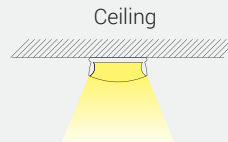
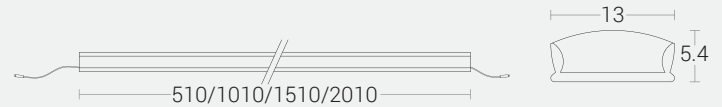

Housing Colour

- Powder coated finish in RAL9016 White fine texture

Accessories



Mounting clip

ID	Description
8342	Mounting Clip

- * Fixture manufactured to desired length with multiples of 500mm (not to be cut at site)
- * Driver and mounting accessories to be ordered separately

Light Distribution refer online



Open source



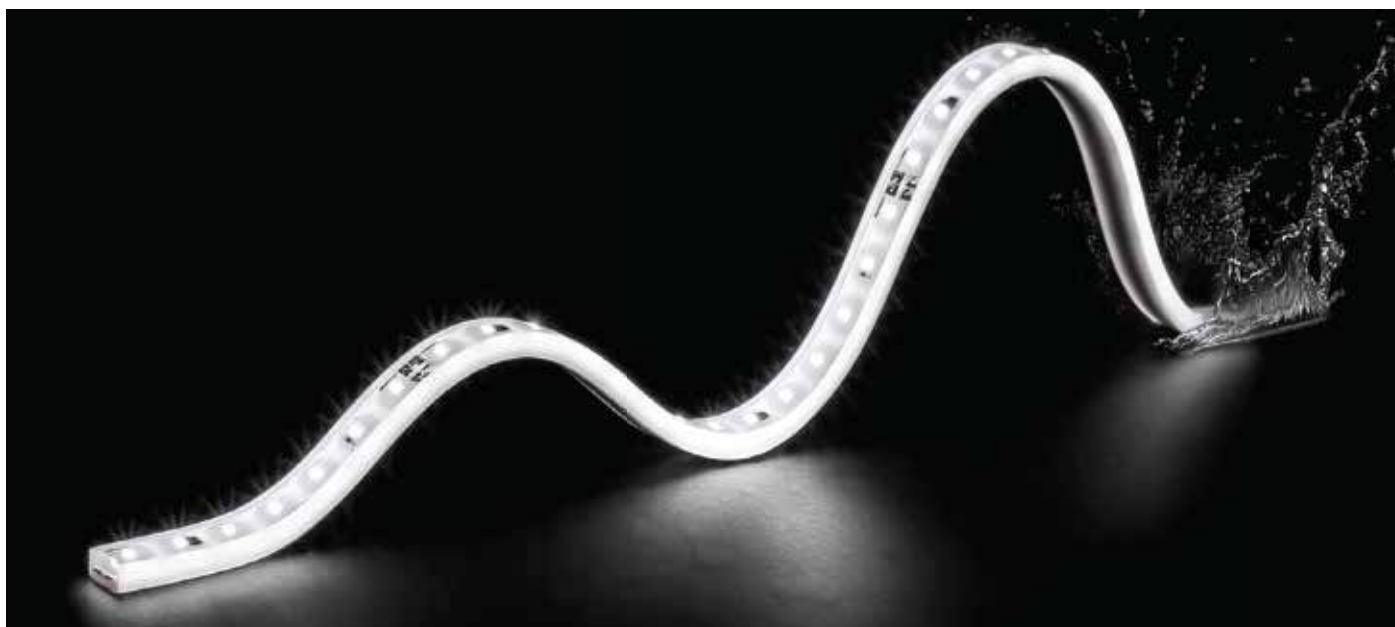

Open Source

Technical Specifications

Light Source

Light Source	: LUMILEDS
CRI (Ra)	: >80 (>90 on request)
LED Colour Temperature	: 2700K / 3000K / 4000K (Special colours on request)

Physical

Body	: High-Grade Horizontal Bend Elasto Polymer with Endcaps
Mounting	: Surface
Finish	: White

General

Driver	: Constant Voltage
Input Voltage	: 220-240Vac
Operating Temperature	: -15°C~+50°C
Operating Voltage	: 24Vdc
Power Supply	: Non Integral 24V PSU (IP67)

Specification

Power (W/m)	10W/m
Max.length (m)	2 mts
Max.serial run length (m)	5 mts
Max.ambient temp.(Ta _{max})	50°C

Optical

Tilt	: Fixed
Beam Angle	: 120°
Luminaire Efficiency	: Upto 80 lm/W
Diffuser Material	: Clear Polyurethane Encapsulation

- The given data are standard values. Due to tolerances of the manufacturing process and the electrical components, photometric values and electrical power can vary up to 10 - 12%.
- Luminous flux upto -40% with opal transmission.
- In IP67 encapsulated products, tolerance in colour temperature can occur.
- Light distribution refer online



Ordering Guide

Surface - Direct

ID	Wattage	Dimension (mm)
3591	5W	510 x 13 x 5.4
3592	10W	1010 x 13 x 5.4
3593	15W	1510 x 13 x 5.4
3594	20W	2010 x 13 x 5.4

Technical specification varies

* Voltage drop information refer to page no: 67

K-LITE

Aster-15, Flexible

Power : 5W 10W 15W 20W
Length : 520mm 1020mm 1520mm 2020mm

Features

- LUMILEDS LED's
- CRI Ra>80 (>90 on request)
- SDCM ≤ 3
- L80 / B10 @ 60,000 Hrs
- For ready use with IP67 connectors
- Encapsulated linear luminaire
- IP67 protection class

Options

- CCT : 2700K / 3000K / 4000K
(Special colour on request)
- Driver options



Dimension in mm

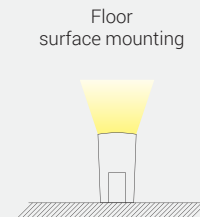
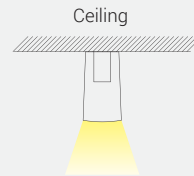
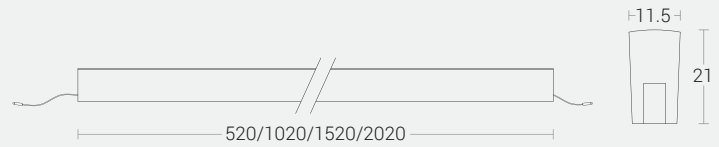

Housing Colour

- Powder coated finish in RAL9016 White fine texture

Accessories



Aluminium mounting clip

ID	Description	Dimension
8257	Aluminium mounting clip	50mm

* Fixture manufactured to desired length with multiples of 500mm (not to be cut at site)

* Driver and mounting accessories to be ordered separately



Open source

Light Distribution refer online

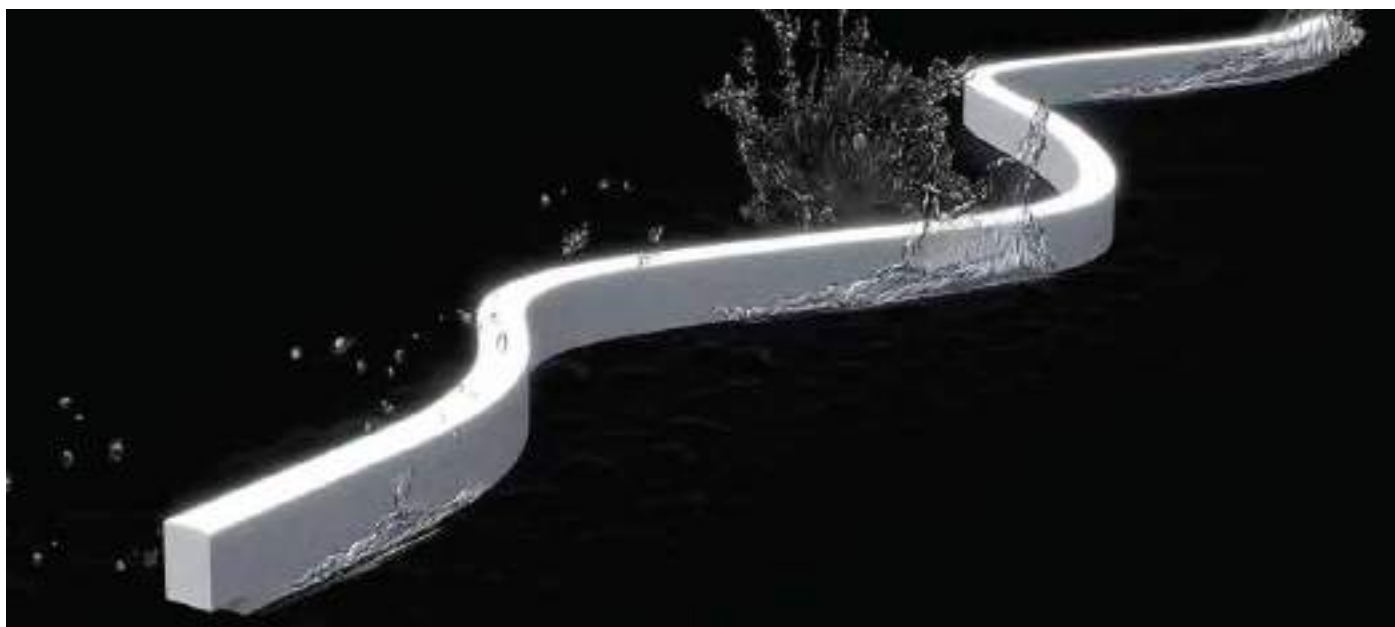

Open Source

Technical Specifications

Light Source

Light Source	: LUMILEDS
CRI (Ra)	: >80 (>90 on request)
LED Colour Temperature	: 2700K / 3000K / 4000K (Special colours on request)

Physical

Body	: High-Grade Horizontal Bend Elasto Polymer with Endcaps
Mounting	: Surface
Finish	: White

General

Driver	: Constant Voltage
Input Voltage	: 220-240Vac
Operating Temperature	: -15°C~+50°C
Operating Voltage	: 24Vdc
Power Supply	: Non Integral 24V PSU (IP67)

Specification

Power (W/m)	10W/m
Max.length (m)	2 mts
Max.serial run length (m)	5 mts
Max.ambient temp.(Ta _{max})	50°C

Optical

Tilt	: Fixed
Beam Angle	: 120°
Luminaire Efficiency	: Upto 80 lm/W
Diffuser Material	: Translucent Polyurethane Encapsulation

- The given data are standard values. Due to tolerances of the manufacturing process and the electrical components, photometric values and electrical power can vary up to 10 - 12%.
- Luminous flux upto -40% with opal transmission.
- In IP67 encapsulated products, tolerance in colour temperature can occur.
- Light distribution refer online



Ordering Guide

Surface - Direct

ID	Wattage	Dimension (mm)
3587	5W	520 x 11.5 x 21
3588	10W	1020 x 11.5 x 21
3589	15W	1520 x 11.5 x 21
3590	20W	2020 x 11.5 x 21

Technical specification varies

* Voltage drop information refer to page no: 67



K-LITE

Post Top Luminaires



TRAPEZOIDAL
6802 E27-A D1 □234 x 304

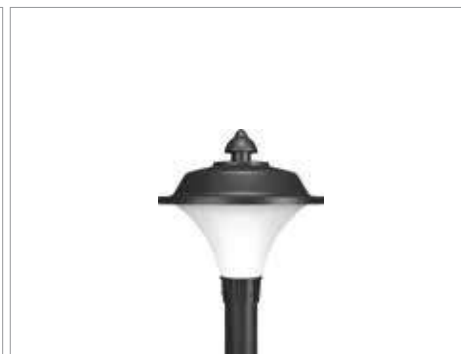

CONIC
6803 E27-A D1 Ø276 x 290



ROMAN ROUND MIDI
5076 E27-B TR D1 Ø250 x 385
4630 12W LED D1 Ø250 x 385



LIGHT HOUSE MINI
5071 E27-B D1 Ø340 x 523



LIGHT HOUSE MIDI
4983 27W LED TR D1 Ø453 x 575
5084 E27-C D1 Ø453 x 575



PRINCE MINI
5073 E27-B D1 Ø340 x 505



PRINCE MIDI
4985 27W LED TR D1 Ø454 x 575
5088 E27-C D1 Ø454 x 575



HELIA MIDI - CUTOFF
4946 E27-C D1 Ø336 x 477
4986 24W LED D1 Ø336 x 477



PRINCE ORNA MINI
5072 E27-B D1 Ø293 x 480



PRINCE ORNA MIDI
4984 27W LED TR D1 Ø454 x 575
5087 E27-C D1 Ø454 x 575



BEACON - METRO
5478 E27-A D1 Ø218 x 292



BEACON METRO MEGA
5477 30W LED D2 Ø410 x 417



BEACON LUCY
4510 50W LED D2 Ø410 x 574



ZUCCHINI
4849 30W LED D1 Ø166 x 605



LUCY
4850 30W LED D2 Ø171 x 675
5493 50W LED D2 Ø171 x 675



TAGALOG
5368 50W LED D3 465 x 550 x 120



ANI
4975 30W LED D1 Ø426 x 322



AVIRA
4976 30W LED D2 Ø504 x 380



NEW
GEMA
4520 30W LED D2 Ø590 x 450



PARAMOUNT
4977 50W LED D1 Ø590 x 322



JUNO MIDI
5380 36W LED D1 Ø420 x 420



JUNO
5040 60W LED D2 Ø600 x 443



KESHAV
4502 50W LED D1 Ø487 x 577
5384/4503 50W/100W LED D1 Ø487 x 577



STENCIL
5383 40W LED D2 692 x Ø107 x 770



REFLECTO DIXON MEGA
4925 50W LED D13 Ø900 x 1045



GANTHAL
5027 30W LED D3 Ø700 x 450



ROMINA
4493 30W LED D3 Ø400 x 616
5445 50W LED D3 Ø400 x 616
4523 30W LED D3 Ø400 x 616
4524 50W LED D3 Ø400 x 616



ASTRAL
4492 30W LED D3 Ø400 x 807
5444 50W LED D3 Ø400 x 807
4521 30W LED D3 Ø400 x 807
4522 50W LED D3 Ø400 x 807



GENESIS		
5435	E27-D	D2 480 x 417 x 850
5436	50W LED	D2 480 x 417 x 850



GADAI		
4918	E27-D	D3 Ø435 x 932
4998	50W LED	D3 Ø435 x 932



MAGUDAM MIDI		
4920	E27-D	D1 Ø350 x 655
4932	30W LED	D1 Ø350 x 655



MAGUDAM		
4919	E27-D	D3 Ø495 x 960
4999	50W LED	D3 Ø495 x 960

Dynasty
Diffuser Options



C0 - Without Diffuser



C1 - Textured Diffuser



C2 - Translucent Diffuser



DYNASTY MIDI		
4635 C1/C2	E27	D1 □325 x 545
4509 C1/C2	30W LED	D1 □325 x 545
4514 C0	30W LED	D1 □325 x 545
4636 C1/C2	50W LED	D1 □325 x 545
4515 C0	50W LED	D1 □325 x 545



DYNASTY		
4917 C1/C2	E27-D	D2 □445 x 741
4640 C1/C2	50W LED	D2 □445 x 741
4506 C0	50W LED	D2 □445 x 741



RING FORT ARC MICRO

5189 A8/A9	E27	D6 Ø300 x 550
4978 A8/A10	30W LED	D6 Ø300 x 550



RING FORT ARC MINI

5353 A8/A9/A12	E27	D1 Ø425 x 710
5000 A8/A10	30W LED	D1 Ø425 x 710
5192 A9/A12	30W LED	D1 Ø425 x 710
4518 A9/A12	50W LED	D1 Ø425 x 710



IMPERIAL MINI

5372 A8/A9/A12	E27	D1 Ø425 x 632
5373 A8/A10	30W LED	D1 Ø425 x 632
4516 A9/A12	30W LED	D1 Ø425 x 632
4517 A9/A12	50W LED	D1 Ø425 x 632



Diffuser Options

A8 - Translucent Acrylic



A9 - Clear Acrylic



A10 - Translucent Acrylic



A12 - Clear Polycarbonate



Eg. : ID No.+A8

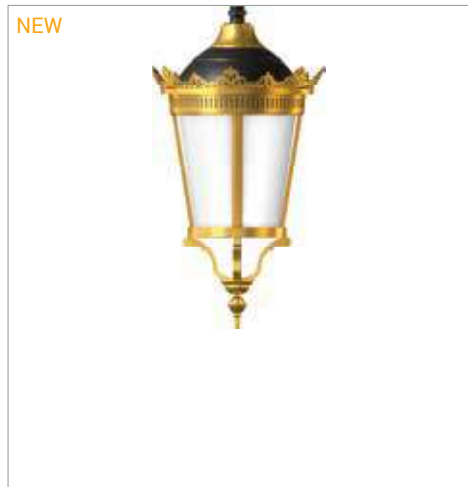

NEW

MAGUDAM MIDI

4607	E27-D	D4 Ø358 x 670
4608	30W LED	D4 Ø358 x 670

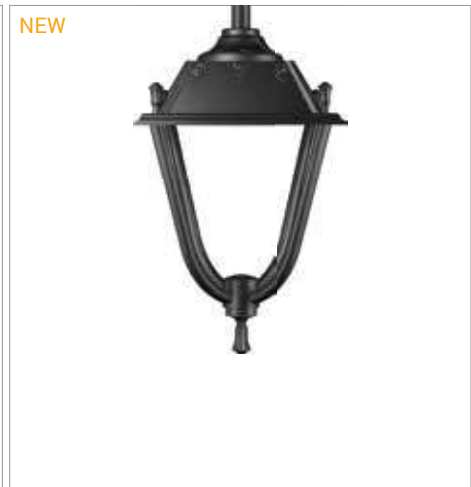

NEW

RATHA

4612	50W LED	D4 □445 x 713
------	---------	---------------



KARONA FORT MINI

5187 A11	30W LED	D4 Ø475 x 437
4624 A11	50W LED	D4 Ø475 x 437



KARONA FORT

6800	100W LED	D4 Ø645 x 596
4620	150W LED	D4 Ø645 x 596



MAGNUM

4621	200W LED	Ø710 x 545
------	----------	------------



HONEYDROP

4941	100W LED	D2 Ø512 x 805
4622	150W LED	D2 Ø512 x 805



ERICA

4623 30W LED D4 Ø200 x 330



Gobariya Bawadi, UIT Kota, Rajasthan



PELICAN FORT MICRO

5311 A8/A9 E27 D4 Ø300 x 290
4979 A8/A10 30W LED D4 Ø300 x 290/210



PELICAN FORT MINI

4899 A8/A9/A12 E27 D4 Ø425 x 407/437
5188 A9/A12 30W LED D4 Ø425 x 407/437
4980 A8/A10 30W LED D4 Ø425 x 407/290
4897 A9/A12 50W LED D4 Ø425 x 407/437



PELICAN FORT

6791 A9/A12 50W LED D4 Ø634 x 618/676
6799 A9/A12 100W LED D4 Ø634 x 618/676



A8 - Translucent



A9 - Clear



A10 - Translucent Acrylic



A12 - PC Clear

DIFFUSER OPTIONS

Eg. : ID Nos.+A9



IMPERIAL MINI

4890 A8/A9/A12 E27 D4 Ø425 x 401/431
4891 A9/A12 30W LED D4 Ø425 x 401/431
4892 A8/A10 30W LED D4 Ø425 x 401/285
4893 A9/A12 50W LED D4 Ø425 x 401/431



IMPERIAL

5138 A9/A12 50W LED D4 Ø634 x 673/731
5139 A9/A12 100W LED D4 Ø634 x 673/731

K-LITE

Avenue - Street Lights 

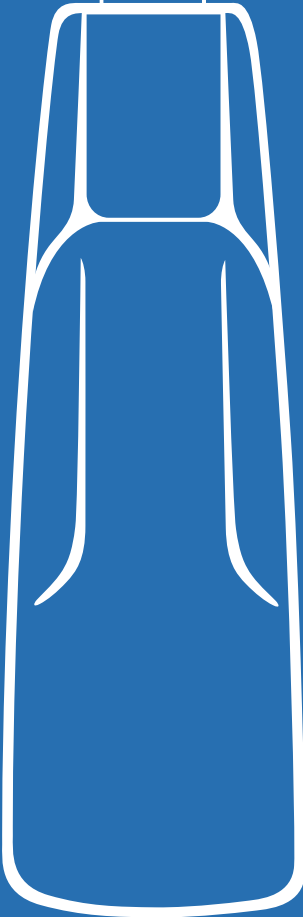
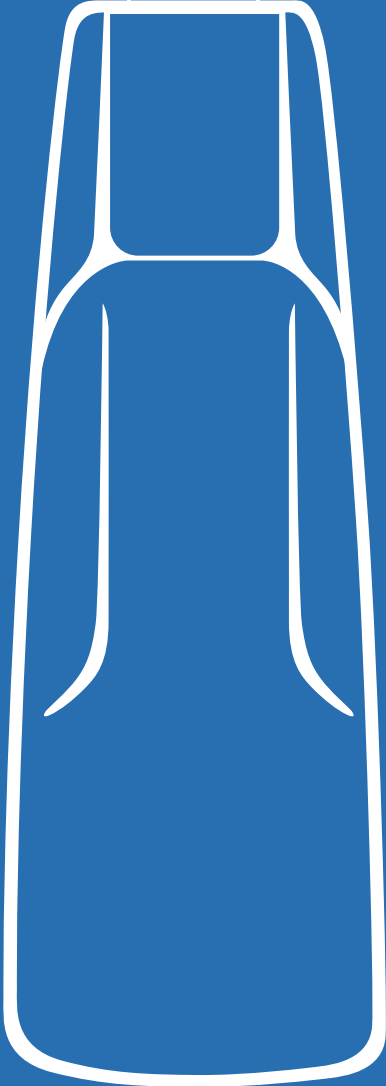

AVENUE 100

ID : 4392

Sys. Luminaire Power :

100W

Available body colours :

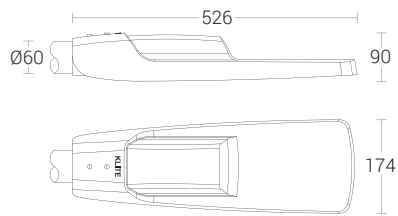

AVENUE 40

ID : 4391

Sys. Luminaire Power :

40W

Available body colours :

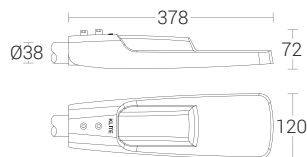

K-LITE

Waco Pro - Street Lights 



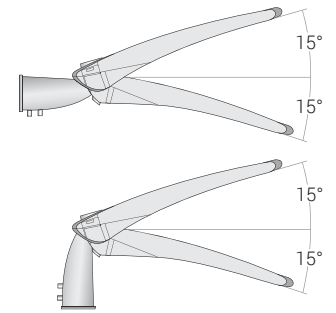
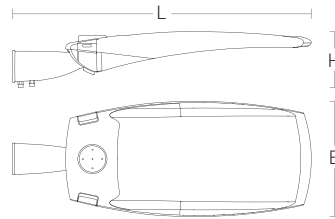
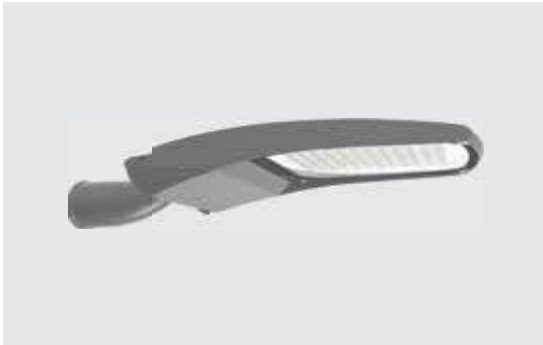

Bracket with a tilting system from -15° to +15°

Product Code	KL-4291	KL-4292	KL-4290
Input Wattage	60W - 100W	120W - 150W	200W - 300W
Installation Pipe Diameter	Ø45/60mm	Ø45/60mm	Ø45/60/76mm
Luminous Flux	7800-15000 lm	15600-22500 lm	26000-45000 lm
Color Temperature	3000~5700K		
Input Voltage	AC90~305V		
Frequency Range	50/60Hz		
Power Factor	PF≥0.9		
Color rendering index	Ra≥70		
Temperature of Working Condition	-40~50°C		
Humidity of Working Condition	20%~90%RH		
LED Lifetime	50000h		
Protectin Grade	IP66		
Protection level	IK08		
Installation Height	4-8m	6-10m	10-14m
Dimension (L x B x H)	645 x 257 x 147	790 x 305 x 147	890 x 361 x 163

Luminaire Use

According to the Lamp Post Height

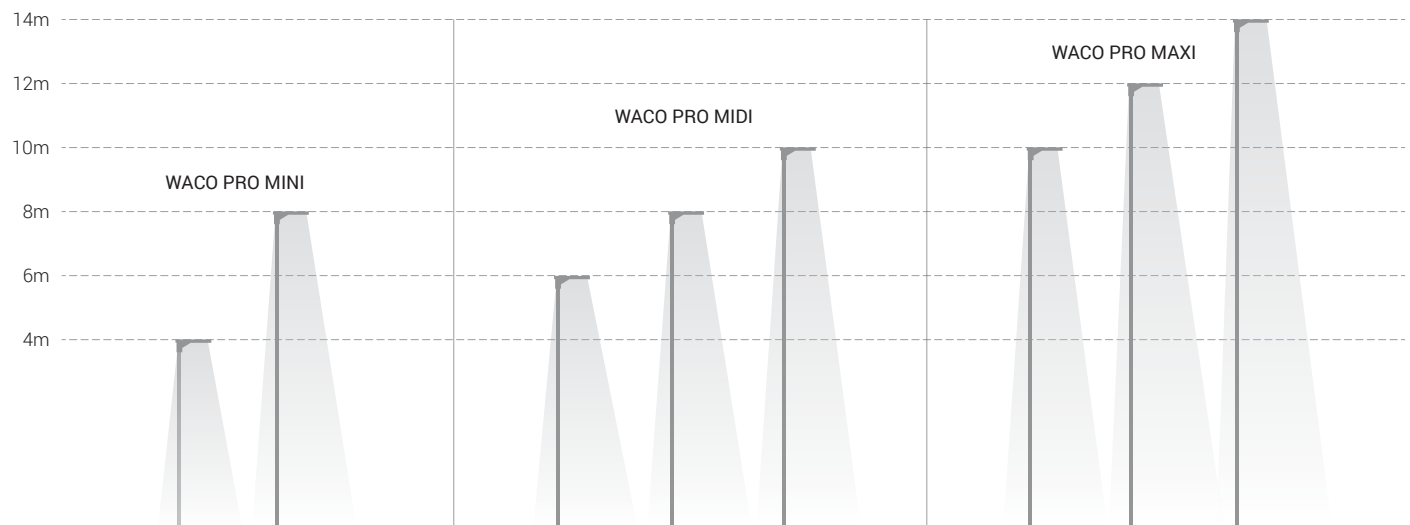



HALES
 5133 30W LED D14 525 x 239 x 160
 4176 50W LED D14 525 x 239 x 160



NIMBA MINI
 5150 30W LED D1 528 x 220 x 160
 4304 50W LED D1 528 x 220 x 160



FALCON
 3810 100W LED D12 697 x 325 x 293



ZIMBA
 4159 50W LED D12 587 x 292 x 204
 4160 100W LED D12 587 x 292 x 204



JAMAL - ADJUSTABLE
 6790 50W LED D2 697 x 488 x 192
 6300 100W LED D2 697 x 488 x 192



SEAGULL MEGA
 4158 150W LED D3 1405 x 420 x 745



DOLPHIN
 5131 100W LED D27 806 x 457 x 300
 5132 150W LED D27 806 x 457 x 300
 4171 200W LED D27 806 x 457 x 300



VISOR
 6583 50W LED M18 386 x 454 x 1000

Traffic Grey Only



RAY

ID : 4175 / 4163 / 4164 / 4174

Sys. Luminaire Power :

60W / 120W / 180W / 240W

Available body colours :

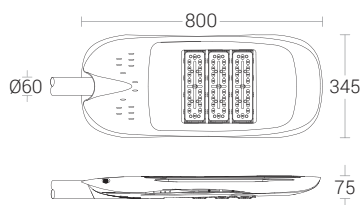



NAVIRA

Series

NAVIRA MINI WALL BRACKET

4971	30W LED W33	N13 220 x 170 x 260
4444	50W LED W33	N13 220 x 170 x 260

NAVIRA MINI

4438	SA	30W LED	292/306/300/320 x 170 x 260
4445	SA	50W LED	292/306/300/320 x 170 x 260
4439	DA	60W LED	495/512/520/540 x 170 x 260
4446	DA	100W LED	495/512/520/540 x 170 x 260

D3 / D26 / D15 / D16

NAVIRA

4447	SA	100W LED	442/456/450/470 x 214 x 260
4448	DA	200W LED	795/812/820/840 x 214 x 260

D3 / D26 / D15 / D16

 Luminaire to be ordered with suitable Aluminium Pole / Circular Pole / Quadra Pole

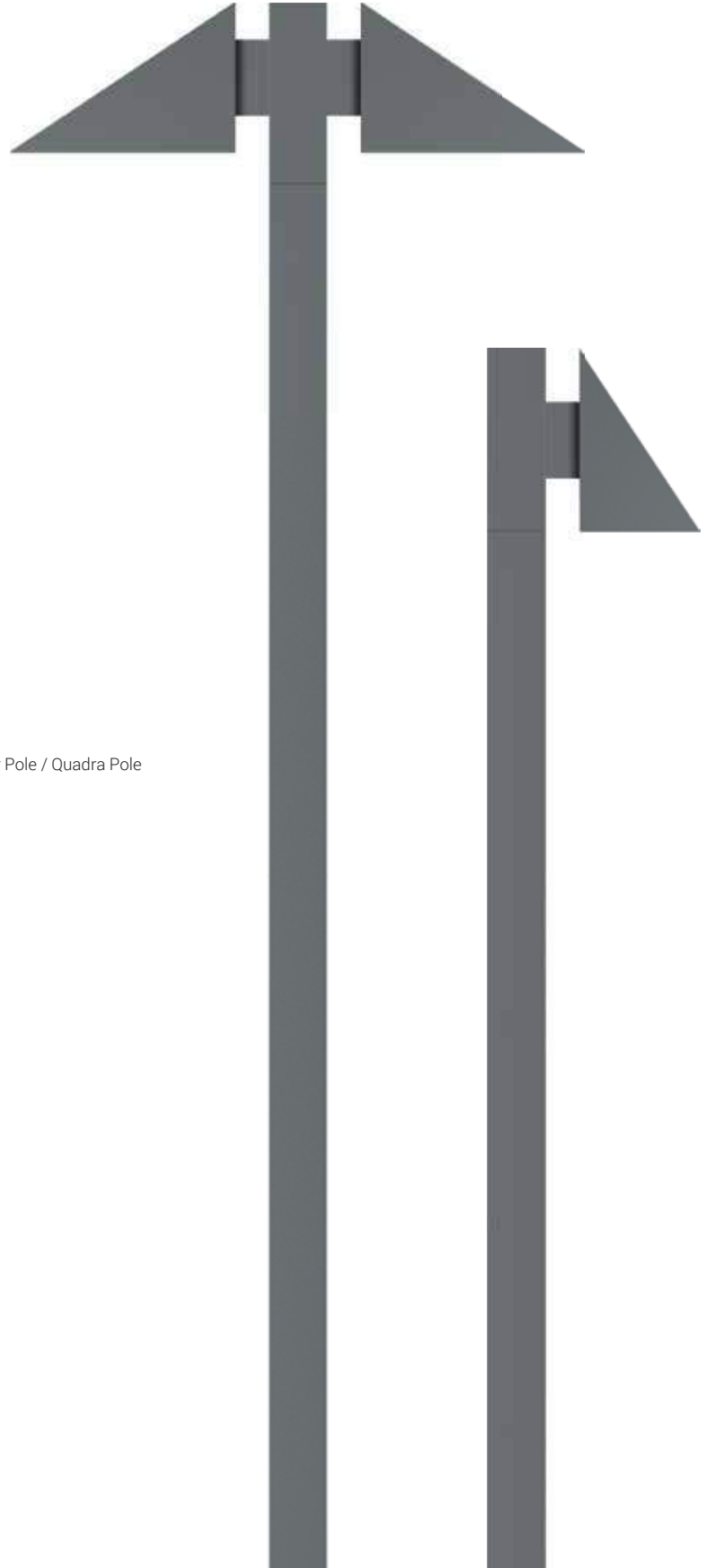

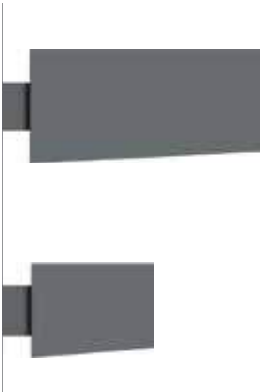

NAVYA

Series

NAVYA MINI / NAVYA WALL BRACKET

4367	24W LED W32	250 x 50 x 153
4368	48W LED W32	450 x 50 x 195

NAVYA MINI

4440	SA	24W LED	333/345/330/350 x Ø88.9/Ø100/□80/□100 x 260
4441	DA	48W LED	577/589/580/600 x Ø88.9/Ø100/□80/□100 x 260

D3 / D26 / D15 / D16

NAVYA

4442	SA	48W LED	533/545/530/550 x Ø88.9/Ø100/□80/□100 x 260
4443	DA	96W LED	974/989/979/997 x Ø88.9/Ø100/□80/□100 x 260

D3 / D26 / D15 / D16

 Luminaire to be ordered with suitable Aluminium Pole / Circular Pole / Quadra Pole





CUBUS

Series

CUBUS WALL BRACKET

4970 30W LED W32 N13 171 x 121 x 200

CUBUS

4436 SA 30W LED 254/266/251/271 x 121 x 260

4437 DA 60W LED 419/431/422/442 x 121 x 260

D3 / D26 / D15 / D16

 Luminaire to be ordered with suitable Aluminium Pole / Circular Pole / Quadra Pole





EZHIL

Series

4968	30W LED	D16 735 x 122 x 985
4969	50W LED	D16 735 x 122 x 985

 Luminaire to be ordered with suitable Aluminium Pole / Circular Pole / Quadra Pole





KAYAL

Series

KAYAL MINI - WALL BRACKET

4370 30W LED W32 N13 211 x Ø166 x 110

KAYAL - WALL BRACKET

4371 50W LED W33 N13 260 x Ø210 x 110

KAYAL MINI - VERTICAL MOUNTING

4372 SA 30W LED 284/296/282/302 x Ø166 x 260

4374 DA 60W LED 478/491/485/505 x Ø166 x 260

D3 / D26 / D15 / D16

KAYAL - VERTICAL MOUNTING

4373 SA 50W LED 328/340/327/347 x Ø210 x 260

4375 DA 100W LED 567/580/573/593 x Ø210 x 260

D3 / D26 / D15 / D16

 Luminaire to be ordered with suitable Aluminium Pole / Circular Pole / Quadra Pole

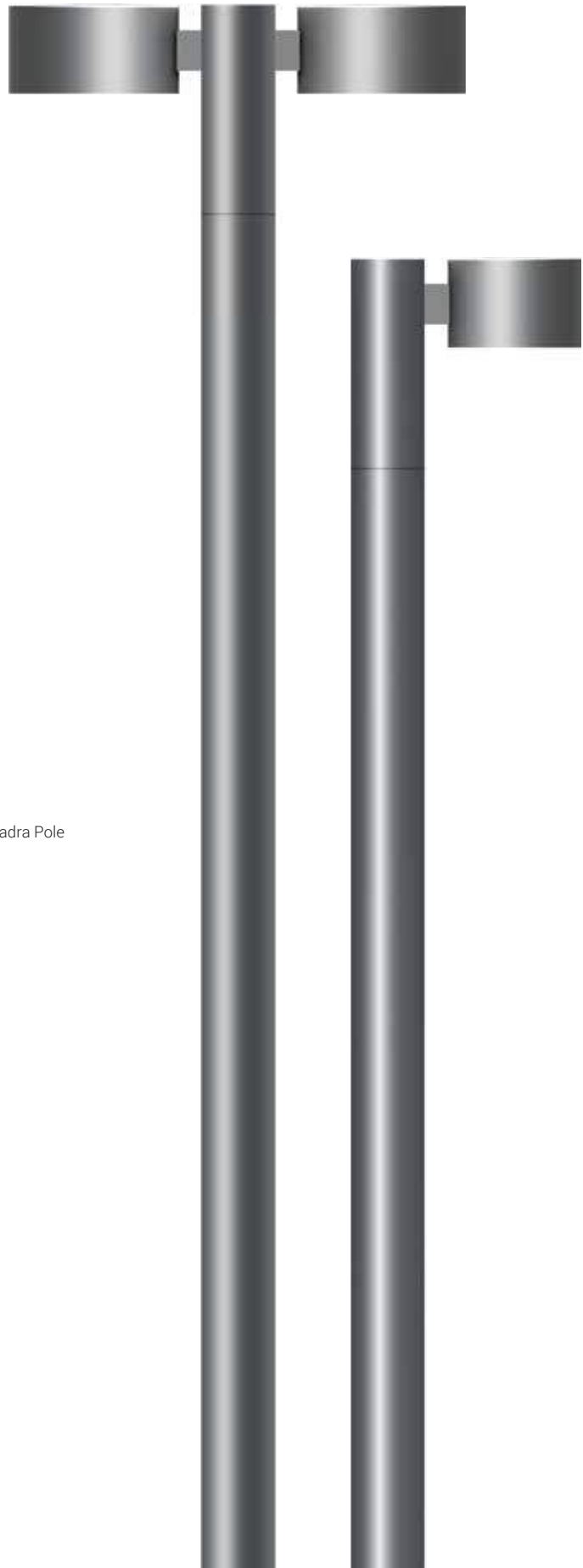



SPECTRA

Series

SPECTRA - WALL BRACKET

4449	50W LED W38	450 x 200 x 50
------	-------------	----------------

SPECTRA

4432	50W LED	587/600/575/595 x 200 x 160
------	---------	-----------------------------

4433	100W LED	587/600/575/595 x 200 x 160
------	----------	-----------------------------

D3 / D26 / D15 / D16

DUAL SPECTRA

4434	100W LED	1080/1093/1071/1091 x 200 x 160
------	----------	---------------------------------

4435	200W LED	1080/1093/1071/1091 x 200 x 160
------	----------	---------------------------------

D3 / D26 / D15 / D16

 Luminaire to be ordered with suitable Aluminium Pole / Circular Pole / Quadra Pole





ANGLE POLAR



POLAR



POLAR

Series

ANGLE POLAR

4413	24W LED W36	600 x □63 x 178
------	-------------	-----------------

POLAR

4414	30W LED W37	600 x 120 x 80
------	-------------	----------------

4415	50W LED W37	600 x 120 x 80
------	-------------	----------------

4416	60W LED W37	600 x 120 x 80
------	-------------	----------------

POLAR - VERTICAL MOUNTING

4417	30W LED	600 x 120 x 240
------	---------	-----------------

4418	50W LED	600 x 120 x 240
------	---------	-----------------

D3 / D26 / D15 / D16

DUAL POLAR - VERTICAL MOUNTING

4419	60W LED	1200 x 120 x 240
------	---------	------------------

4420	100W LED	1200 x 120 x 240
------	----------	------------------

D3 / D26 / D15 / D16

 Luminaire to be ordered with suitable Aluminium Pole / Circular Pole / Quadra Pole

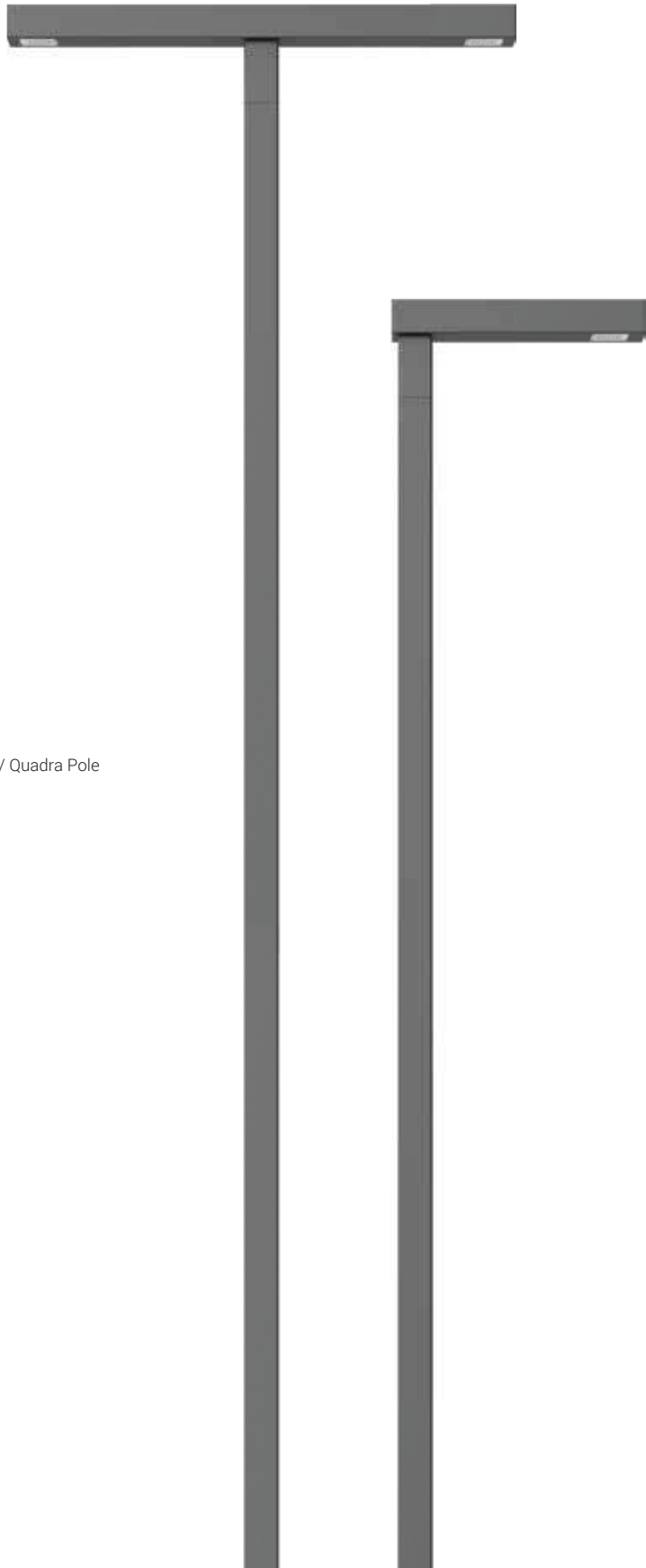



80mm



MEGA POLAR

Series

MEGA POLAR - VERTICAL MOUNTING

4421	50W LED	900 x 120 x 240
4422	60W LED	900 x 120 x 240

D26 / D16

DUAL MEGA POLAR - VERTICAL MOUNTING

4423	100W LED	1800 x 120 x 240
4424	120W LED	1800 x 120 x 240

D26 / D16

 Luminaire to be ordered with suitable Aluminium Pole / Circular Pole / Quadra Pole





100mm



DUO MEGA POLAR

Series

DUO MEGA POLAR - VERTICAL MOUNTING

4425	100W LED	900 x 150 x 260
4426	120W LED	900 x 150 x 260

D26 / D16

DUAL DUO MEGA POLAR - VERTICAL MOUNTING

4427	200W LED	1800 x 150 x 260
4428	240W LED	1800 x 150 x 260

D26 / D16

 Luminaire to be ordered with suitable Aluminium Pole / Circular Pole / Quadra Pole





PRIME SERIES



BEMA 7

Surface Mounted Series

Bema 7 is a compact downlight with textured opal diffuser. It stands out for its natural integration into the ceiling thanks to a perimeter contour of soft lines and slight curvature.

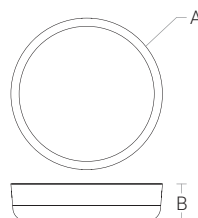

BEMA 7

ID	Wattage	A	B
3612	12W LED	Ø123	43
3613	22W LED	Ø177	43
3614	32W LED	Ø230	43

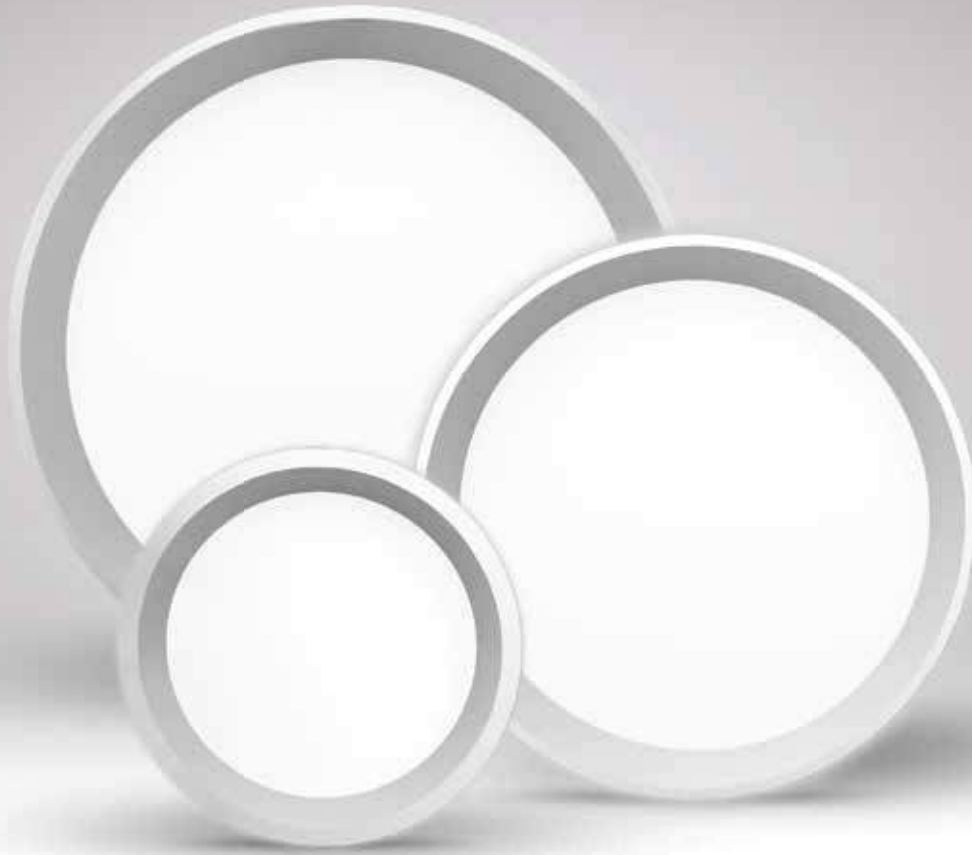

DIVA DEEP

Round & Square Down Lighters

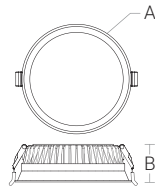

DIVA DEEP ROUND

ID	Wattage	A	B	C.O.D
3321	12W LED	Ø120	50	Ø110
3322	18W LED	Ø148	50	Ø138
3323	24W LED	Ø170	50	Ø160

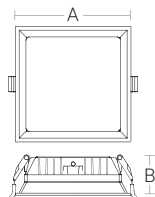

DIVA DEEP SQUARE

ID	Wattage	A	B	C.O.D
3324	12W LED	□110	50	□100
3325	18W LED	□143	50	□133
3326	24W LED	□165	50	□155

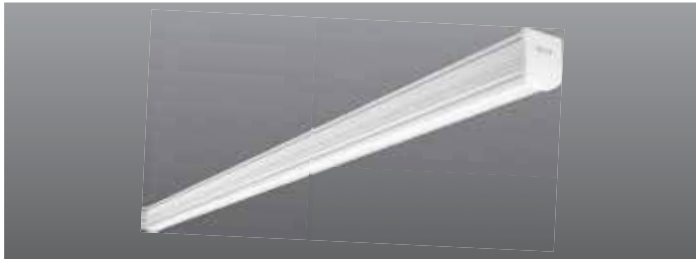

POWER LINE

1588	20W LED	1200 x 43 x 52
1589	40W LED	1200 x 43 x 52

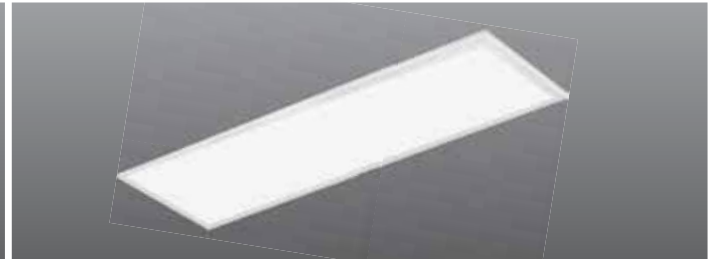

POLAR PANEL - 4 x 1

2287	40W LED	1195 x 295 x 35	1175 x 275
Series Powered by OSRAM			

K-LITE

LED Down Lighters



POLAR PANEL

2281	40W LED	N7 596 x 596 x 32	590 x 590
ID: 8303 - Recess Mounting Clamp			



BEMA SQUARE

7331	16W LED	□112 x 49
7332	22W LED	□167 x 51
7333	36W LED	□211 x 51



ISHA ROUND

3342	12W LED	Ø110 x 27	Ø100
3343	18W LED	Ø132 x 27	Ø122



ISHA SQUARE

3359	12W LED	□110 x 27	□100
3360	18W LED	□130 x 27	□120

Pendant / Surface Luminaires



JUNO MIDI / JUNO	Colour : Silver / Gold / Black
3022	36W LED Ø420 x 80
3009	60W LED Ø600 x 80



SONA MIDI / SONA	Colour : Black
2874	12W LED Ø340 x 102
2875	18W LED Ø410 x 115



ALPINA	Colour : Yellow & Black
3045	E27 Holder Ø360 x 236

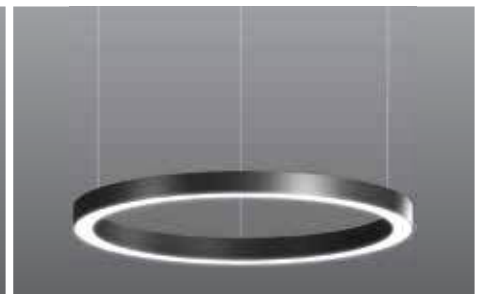

INFINITY	Colour : Black / White / Grey
3232	Upto 36W Ø900 x 25

Luminaires supplied with adjustable suspension kit (1 metre)



BEMA-M	Colour : White / Black
3356	60W LED Ø400 x 54



NILA MIDI / NILA	Colour : White / Black
2876	36W LED Ø400 x 57
2877	36W LED Ø500 x 57



SONA MIDI / SONA	Colour : Black
2882	12W LED Ø340 x 135
2883	18W LED Ø410 x 148



VOLANS WAVY / VOLANS	Colour : White
3174	36W LED Ø497 x 88
3175	36W LED Ø497 x 88



ORCUS	Colour : White
3052	12W LED Ø260 x 90
3053	18W LED Ø335 x 100

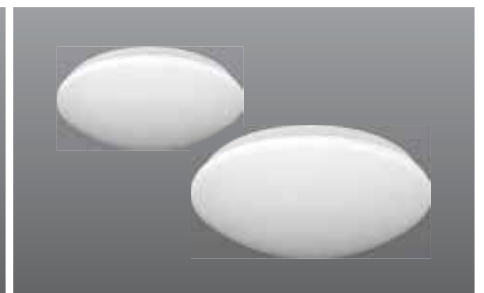

CERES	Colour : White
3054	12W LED Ø260 x 90
3055	18W LED Ø335 x 100

K-LITE
Aarsh Series





K-LITE Aarsh Series

Pendant

2848	Upto 60W	Ø600 x 73
2843	Upto 90W	Ø900 x 73
2820	Upto 120W	Ø1200 x 74

Surface

2850	Upto 60W	Ø600 x 78
2842	Upto 90W	Ø900 x 78
2821	Upto 120W	Ø1200 x 79



K-LITE
Proxima

3677	12W LED	T1 Ø50 x 135 x 177
3678	20W LED	T1 Ø64 x 135 x 200
3679	30W LED	T1 Ø78 x 143 x 236

Available BA 12° / 24° / 36°



HERA			
3351	10W LED	Ø115 x 80	Ø100
3352	20W LED	Ø140 x 65	Ø125
3353	30W LED	Ø160 x 85	Ø145
3354	40W LED	Ø198 x 98	Ø180
3355	50W LED	Ø230 x 102	Ø215



RUBY			
3296	8W LED	Ø62 x 80	Ø55
3298	12W LED	Ø85 x 98	Ø75
3299	25W LED	Ø110 x 121	Ø100



ALINA			
3285	7W LED	Ø65 x 53	Ø58
3286	12W LED	Ø80 x 75	Ø75
3287	18W LED	Ø100 x 95	Ø90



MILA			
3332	12W LED	Ø85 x 72	Ø78
3320	20W LED	Ø108 x 85	Ø95



7803	1 Metre 2 Wire Track
3206	2 Metre 2 Wire Track
7807 / 7814	I / L Connector
7819 / 7824	T / + Connector



TWISTER		
3207	25W LED	T1 Ø71 x 127

Line 'n' Dot - Linear Down Light



SURFACE MOUNTED		
3431	20W LED	312 x 36 x 75
3432	30W LED	462 x 36 x 75

Line 'n' Dot - Linear Wall Washer



SURFACE MOUNTED		
3490	20W LED	312 x 36 x 75
3491	30W LED	462 x 36 x 75



ID : 3369 3W LED



40 x 40

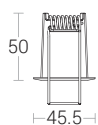

50

45.5

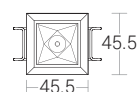

45.5

45.5



ID : 3379 6W LED



100 x 40

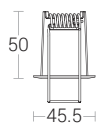

50

45.5

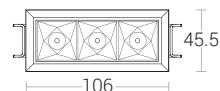

45.5

106



ID : 3370 10W LED



70 x 70

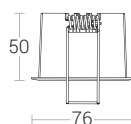

50

76

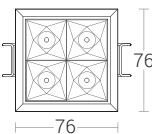

76

76



ID : 3371 12W LED



160 x 40

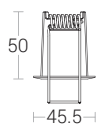

50

45.5

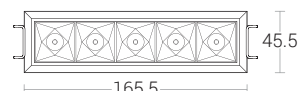

45.5

165.5



ID : 3372 18W LED



100 x 100

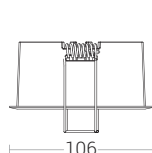

50

106

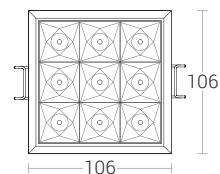

106

106



ID : 3373 24W LED



310 x 40

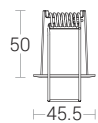

50

45.5

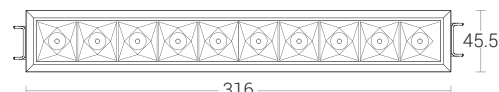

45.5

316





ID : 3374 3W LED



40 x 40

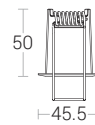

50

45.5

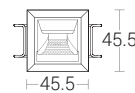

45.5

45.5

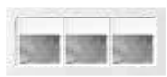

ID : 3381 6W LED



100 x 40

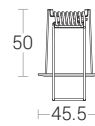

50

45.5

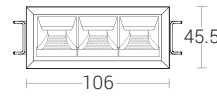

45.5

106

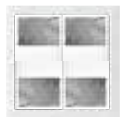

ID : 3375 10W LED



70 x 70

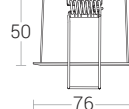

50

76

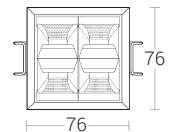

76

76

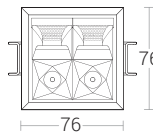

76

76

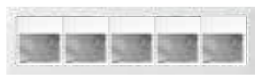

ID : 3376 12W LED



160 x 40

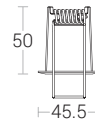

50

45.5

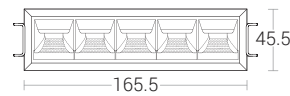

45.5

165.5



ID : 3377 18W LED



100 x 100

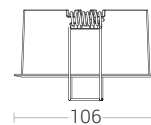

106

106

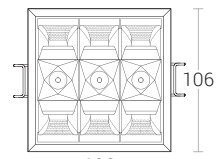

106

106

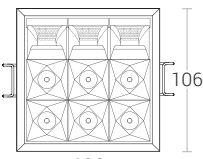

106

106



ID : 3378 24W LED



310 x 40

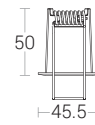

50

45.5

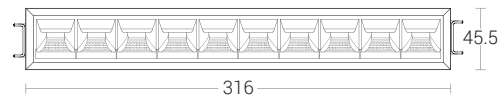

45.5

316





PLATINA

A comprehensive range for hospitality lighting

Made in high density die-cast aluminum for excellent heat management. A wide variety of baffles and forms are available for distinctive architectural requirements. Low UGR and high Colour-Rendering Index features enable Platina to deliver excellent performance & visual comfort. Tunable white and Dimmable are optional solutions.



Trim - Fixed
Optic



Trim - Adjustable
Optic



Trimless - Fixed / Adjustable
Optic

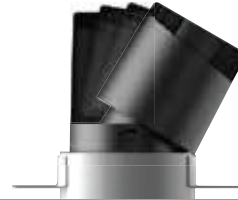
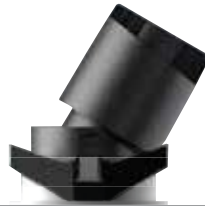

Ø133



Ø133



Ø105



Ø105



Ø92



Ø86



Ø86



Ø72



Ø60



Ø60



Ø50

Colour Options

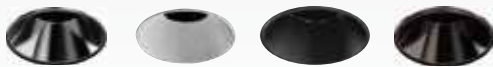

Chrome

White

Black

Black
Chrome

Accessories



Softening
Lens

Elliptical
Lens

Honey Comb
Louver

Easy Maintenance



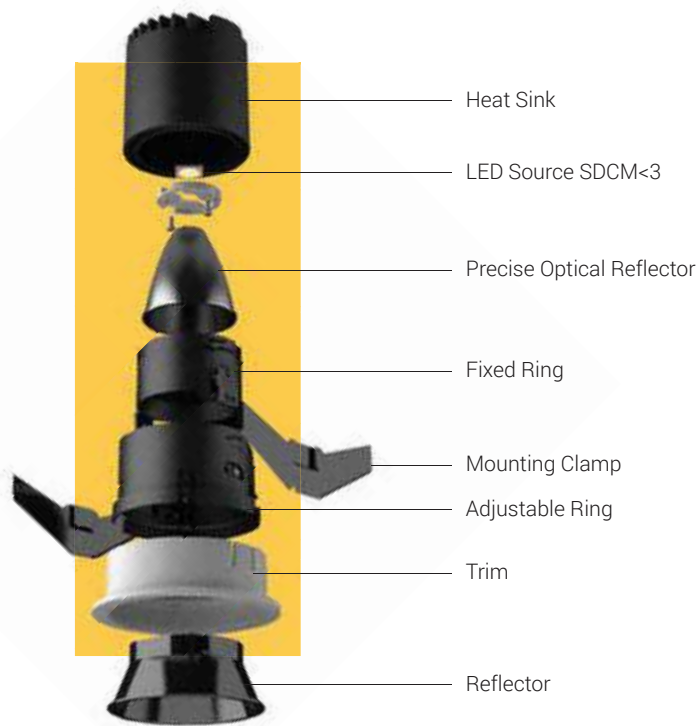

An aesthetic selection of downlighting and wallwashing

Platina is a family of recessed LED spots that comes in a wide range of different sizes and glare-limiting reflector finishes. Symmetrical or asymmetrical optics - either fixed or tiltable - are available.

The variety of luminous flux, appearance options and dimming protocols present Platina as an unbeatable option for architectural lighting applications.



Optimum Performance

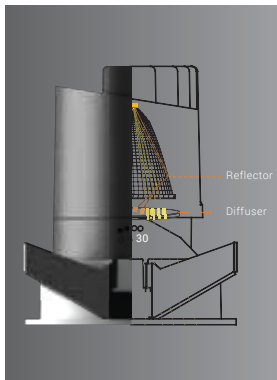

Antiglare - UGR<16

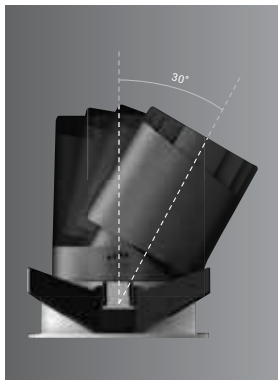

Adjustable upto 30°

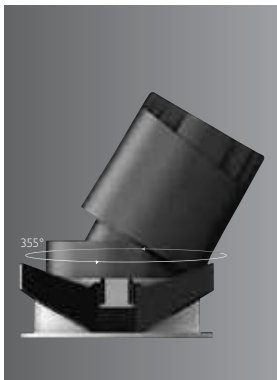

Rotatable 355°



Easy Installation

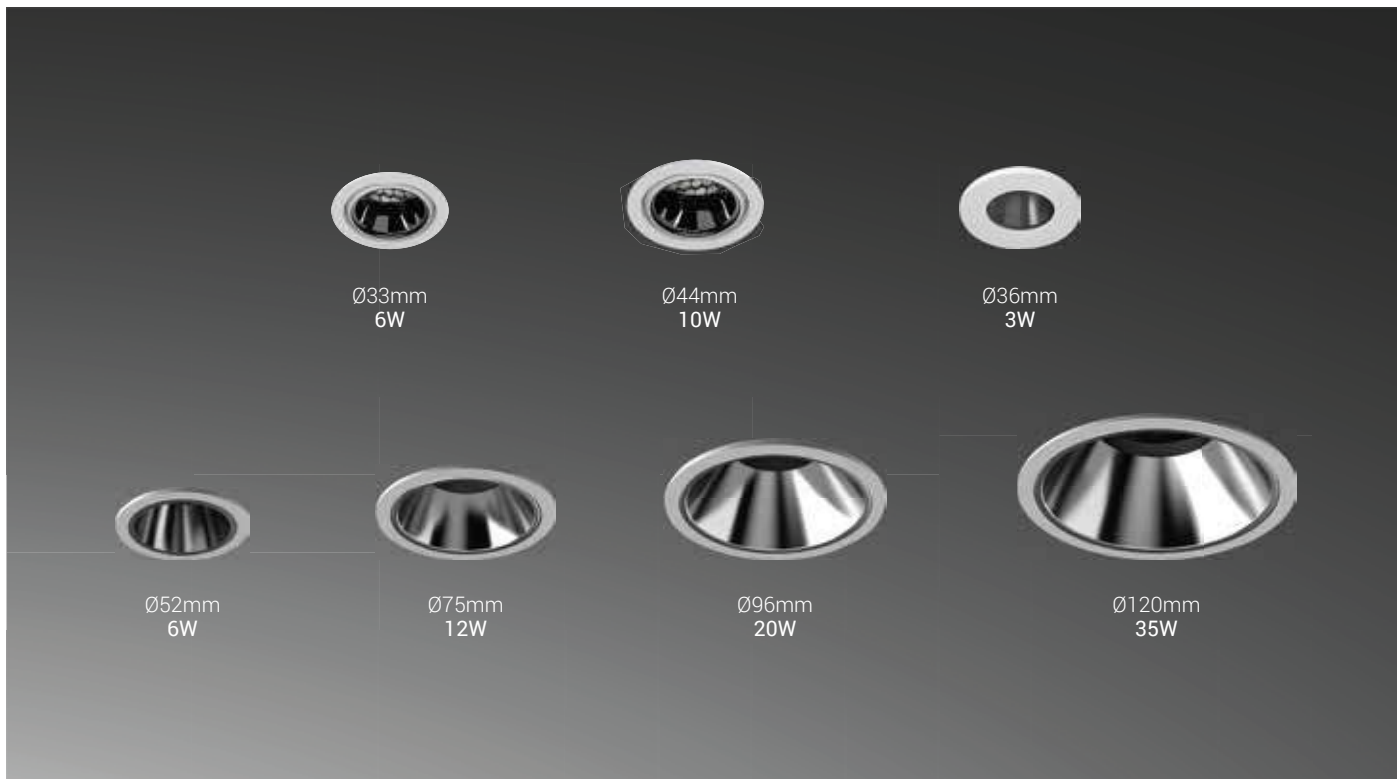

PLATINA MICRO

ID	Wattage	Dimension	C.O.D
3327	6W LED Trim	Ø58 x 75	Ø52
3333	6W LED Trimless	Ø50 x 75	Ø52

PLATINA MINI

3328	12W LED Trim	Ø85 x 104	Ø75
3334	12W LED Trimless	Ø73 x 104	Ø75

PLATINA MIDI

3329	20W LED Trim	Ø105 x 120	Ø96
3335	20W LED Trimless	Ø92 x 120	Ø96

PLATINA MAXI

3330	35W LED Trim	Ø133 x 143	Ø120
3336	35W LED Trimless	Ø181 x 142	Ø120

PLATINA SPOT

3345	3W LED	Ø36 x 57	Ø30
------	--------	----------	-----

SLEEK PLATINA MICRO

3338	6W LED	Ø33 x 91	Ø30
------	--------	----------	-----

SLEEK PLATINA MINI

3339	10W LED	Ø44 x 100	Ø40
------	---------	-----------	-----

PLATINA Spot

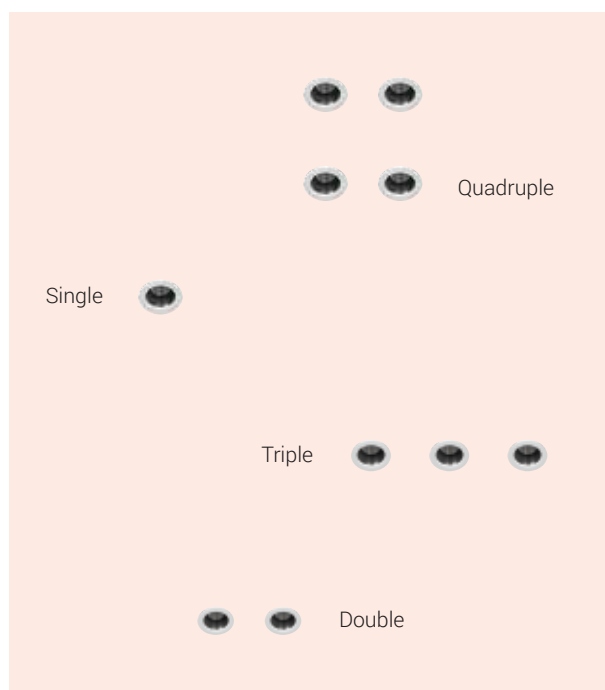

K-LITE

Trisha Module

Technical Specifications

General

ID	: 8177 / 8178 (IP40)
ID	: 8351 / 8352 (IP65)
System Wattage	: 7W / 12W LED
Driver Integral	: Constant Current
Input Voltage	: 230-240Vac
Frequency	: 50-60 Hz
Operating Voltage	: 90-265Vac
Operating Temperature	: 25°~55°C

Light Source

Light Source	: CITIZEN / BRIDGLUX
LED Lumens	: 700 / 1200 lm
CRI (Ra)	: >80 (>90 On Request)
LED Colour Temperature	: 2700K / 3000K / 4000K / 5000K
Life Span	: L70 / B10@ 50,000 Hrs
SDCM	: ≤ 3

Physical

Body	: Die cast aluminium
Diffuser	: Clear Polycarbonate
Mounting	: Recessed



Options

- Driver options



Beam Angle



Optional : Lens / Reflector

NOTE : IP65 on Request

Area of Application

Lobbies & Foyers, Retail Sector, Corporate Office, Residential & Educational premises, Commercial & Business Centres, Hospitality Industry



LED Module



ID : 8177 / 8351 , 7W



ID : 8178 / 8352 , 12W

Dimension Sketch

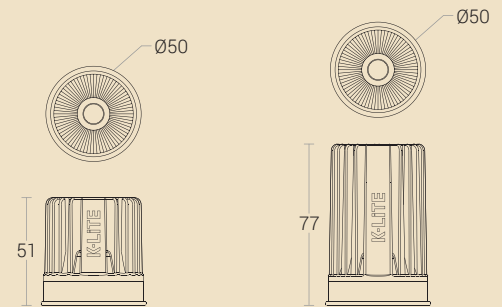

Photometric Data Cone diagram

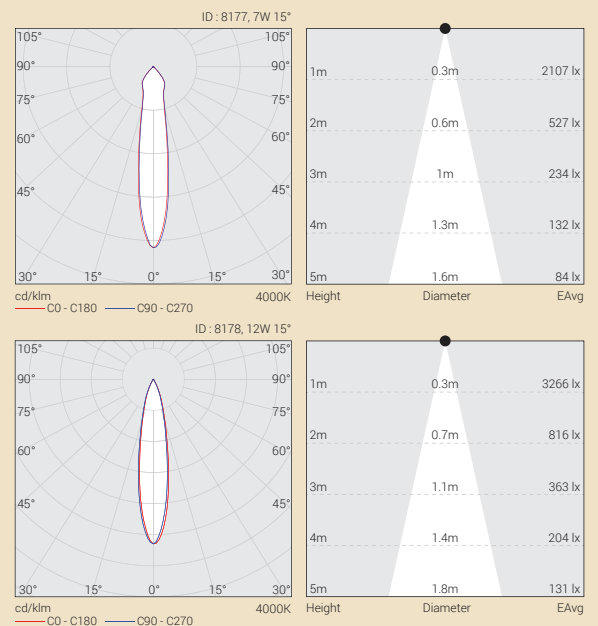

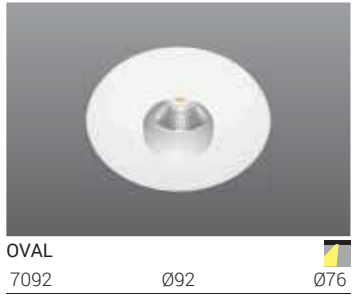

PINHOLE 7736 Ø80 Ø73 **OVAL** 7092 Ø92 Ø76



ROUND ADJ 7081 Ø80 Ø72 **SPOT** 7096 Ø120 Ø110 **ROUND** 7091 Ø92 Ø79 **WASH** 3319 Ø85 GU10 Ø58
 Colour : White & White / White & Gold



SPECK 7095 Ø108 Ø93 **GLOSSY** 7093 Ø90 Ø79



SQUARE WALL WASHER 7086 SQ80 75 x 75 **SQUARE** 7084 SQ80 75 x 75 **ROUND WALL WASHER** 7087 Ø78 Ø72 **ROUND** 7085 Ø78 Ø72
 Colour : White & White / White & Gold Colour : Black & Black / White & Gold



ROUND CHROME 3331 Ø86 x 57 Ø75 **ROUND CHROME - Trimless** 3349 Ø72 x 57 Ø76 **SQUARE CHROME** 3337 □89 x 79 82 **GLARE FREE TWIN** 7089 181 x 102 160 x 82
 Colour : White & White / White & Chrome Colour : White & White / White & Chrome Colour : White & White / White & Chrome

K-LITE

Wall Dena

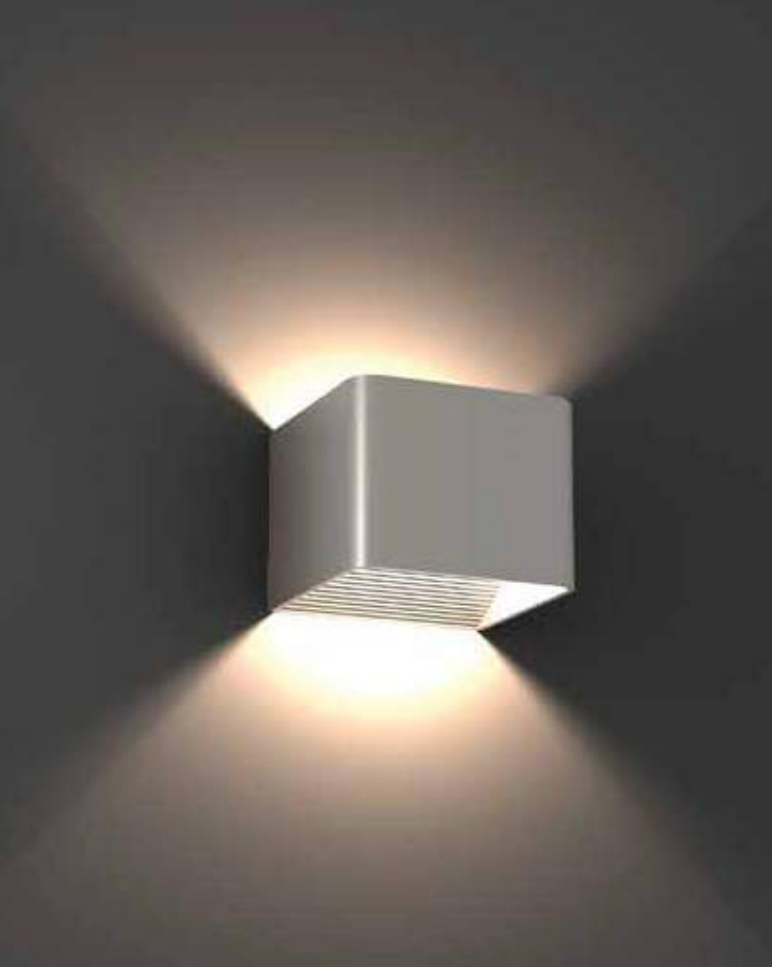

ID	Wattage	Dimension
3980	6W LED W18	111 x 108 x 94
3778	12W LED W19	226 x 108 x 94



Surface Mounted



ASTRA ROUND

3675	5W LED	Ø55 x 75
3683	12W LED	Ø73 x 100
3684	20W LED	Ø94 x 116
3685	30W LED	Ø115 x 125



CUBUS

7348	15W LED	□110 x 120
7349	25W LED	□130 x 135
7350	35W LED	□160 x 165



HIGH BAY		
2869	150W LED	Ø364 x 125
2873	200W LED	Ø410 x 125



POLAR HIGH BAY 1		
3113	1 x 60W LED	342 x 75 x 164



POLAR HIGH BAY 2		
3099	2 x 60W LED	342 x 155 x 205

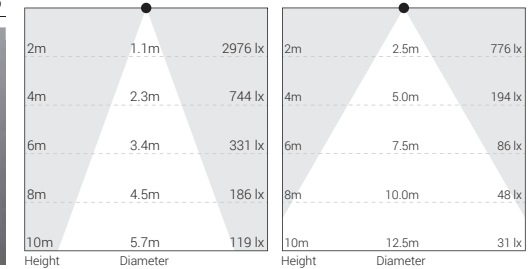
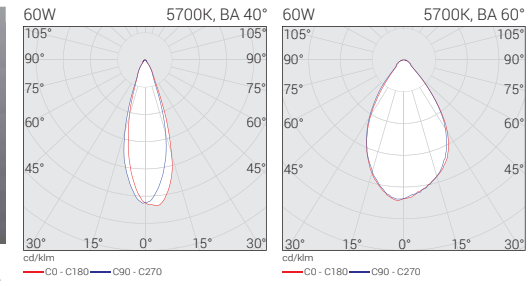

POLAR HIGH BAY 3		
3100	3 x 60W LED	342 x 235 x 245



POLAR HIGH BAY 4		
3098	4 x 60W LED	342 x 315 x 245

IP68 LED Module. BA : 40° / 60°

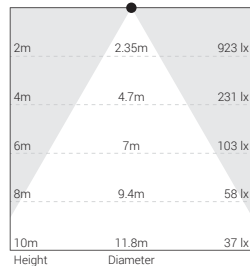
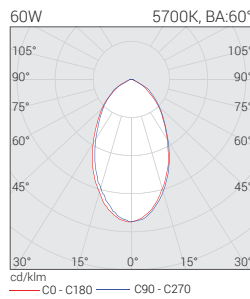
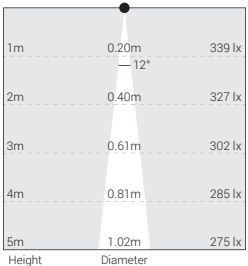
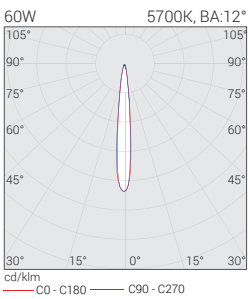

POLAR PRIME HIGH BAY 1		
3187	1 x 60W LED	342 x 75 x 164



POLAR PRIME HIGH BAY 2		
3188	2 x 60W LED	342 x 155 x 205



POLAR PRIME HIGH BAY 3		
3189	3 x 60W LED	342 x 235 x 245



POLAR PRIME HIGH BAY 4		
3190	4 x 60W LED	342 x 315 x 245

IP68 LED Module. BA : 12° / 60°



LED Strip Lights

24V 2835 FLEXIBLE LED STRIP

ID	Wattage	IP	LED's per m	CCT	Cut. length	Width	Packing
7945	6W/m	20	60 pcs	2700-6000K	50mm	8mm	5m / Roll
7281	12W/m	20	120 pcs	2700-6000K	25mm	10mm	5m / Roll
7289	12W/m	67	120 pcs	2700-6000K	25mm	12mm	5m / Roll

K-LITE

LED Linear Lightings - Surface

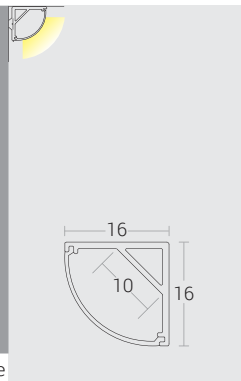
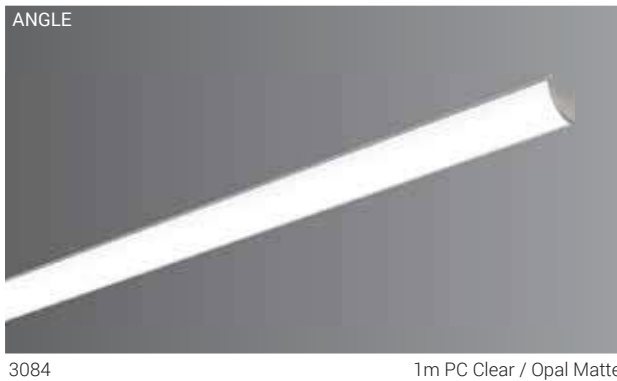
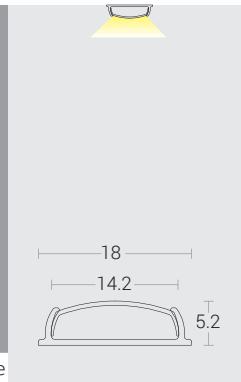

SLIM-S



3082

1m PC Clear / Semi Clear Matte

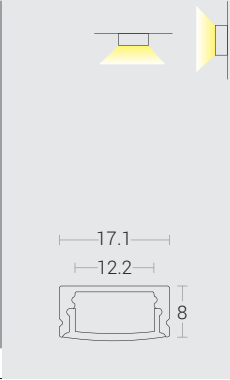

SLIM-R



3225

1m PC Clear / Semi Clear Matte

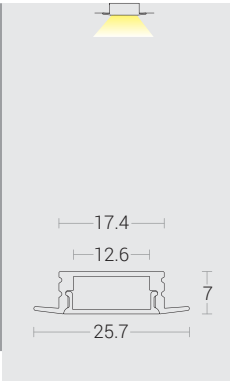

SLIM CUBE-R



3227

1m PC Clear / Semi Clear Matte

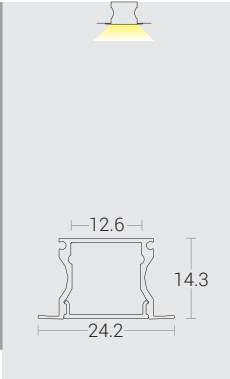

SLIM CUBE-S



3226

1m PC Clear / Semi Clear Matte

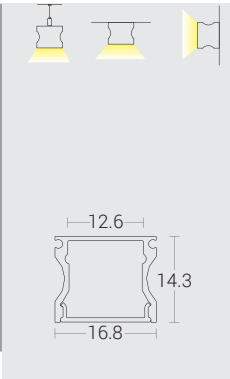



LEVO-S

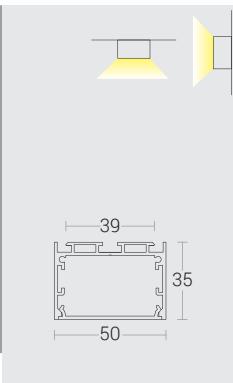
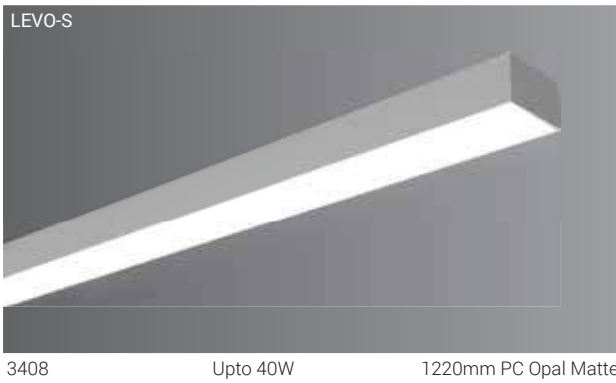

3408

Upto 40W

1220mm PC Opal Matte

LEVO WIDE-S

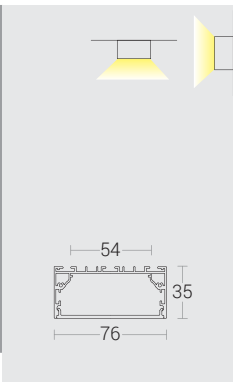
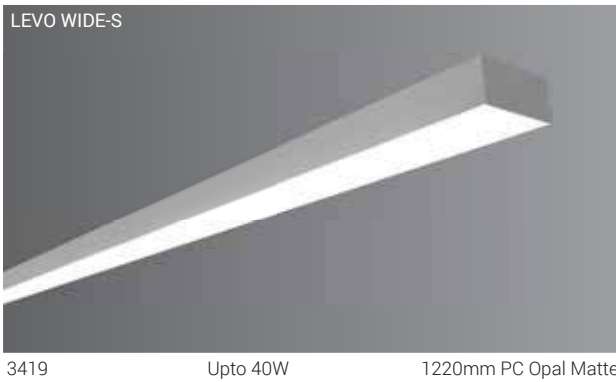

3419

Upto 40W

1220mm PC Opal Matte

UP & DOWN

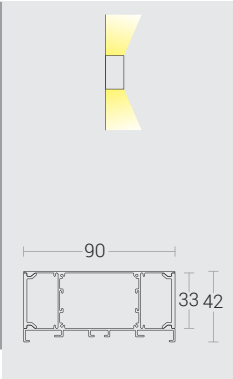

2861

Upto 2 x 20W

1220mm PC Opal Matte



CUBE-R

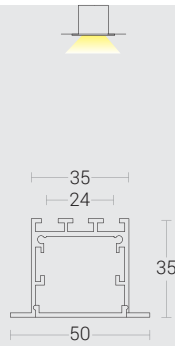
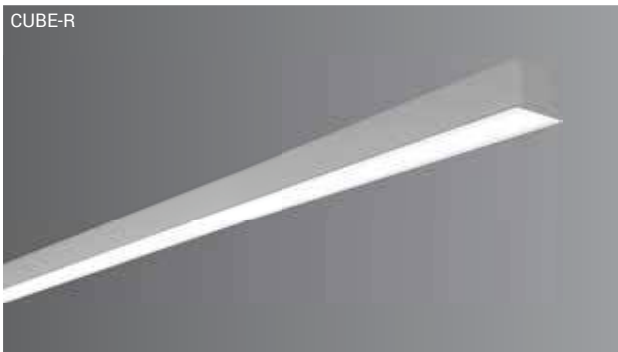

3401 Upto 40W C.O.D: 1205 x 37 1220mm PC Opal Matte

LEVO-R

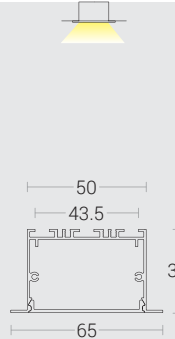
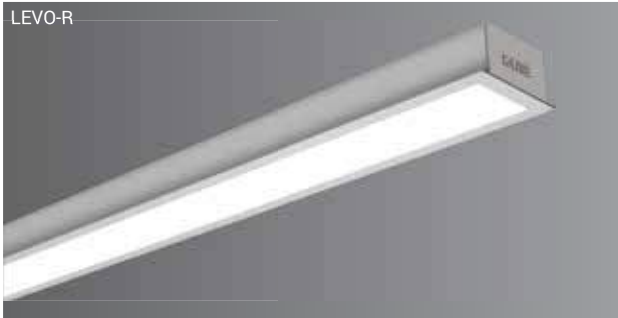

2855/2852 Upto 40W C.O.D:1200x52 1210mm PC Opal Matte/Prismatic
2858/2853 Upto 80W C.O.D:2392x52 2402mm PC Opal Matte/Prismatic

LEVO WIDE-R

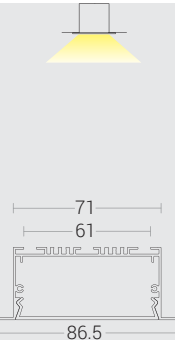

2856/2840 Upto 40W C.O.D:1199x73 1210mm PC Opal Matte/Prismatic
2857/2841 Upto 80W C.O.D:2394x73 2402mm PC Opal Matte/Prismatic

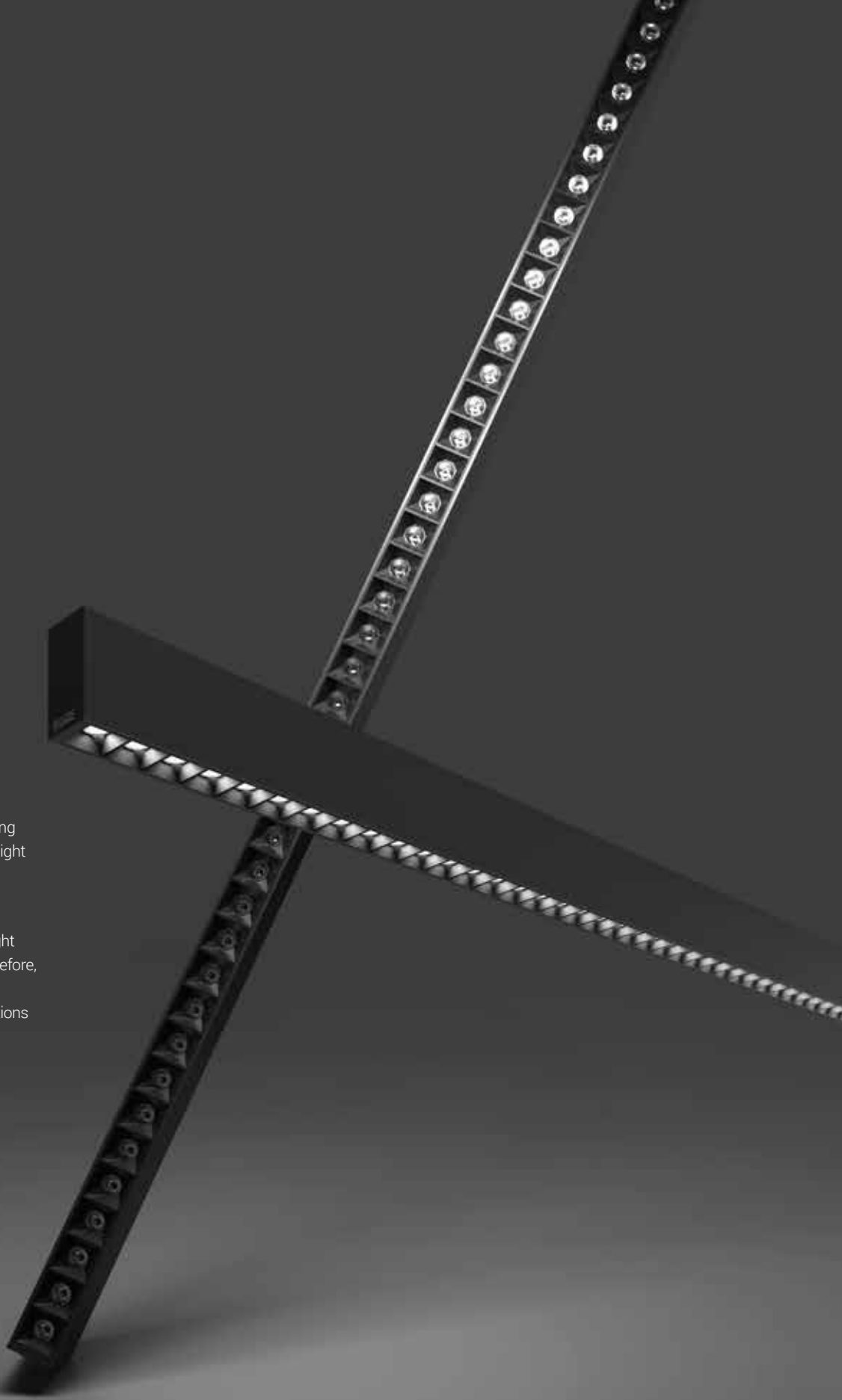

REVO

MINIMALIST

Revo impresses with its up to 3.5 meters long elegant housing, bringing you more quality light with cost-savings.

Due to its length and low UGR, it delivers a homogenous and efficient distribution of light that enables less luminaires per room. Therefore, it is most suitable for open-space offices, corridors, foyers, conference rooms, institutions and other spacious environments.

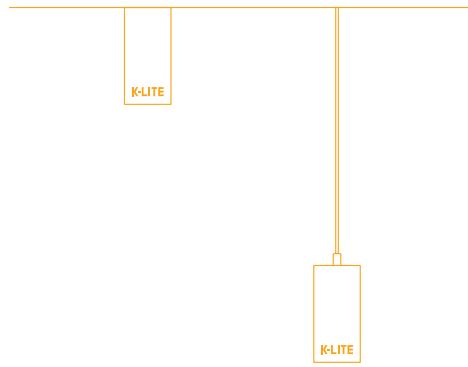

REVO

Flexible Design Multiple Applications

Revo luminaire is a versatile solution for projects that demand high quality of the lighting system and high visual comfort. With its modular design, the Revo can be used as an individual fixture or as a combination of luminaires put together in continuous lines.

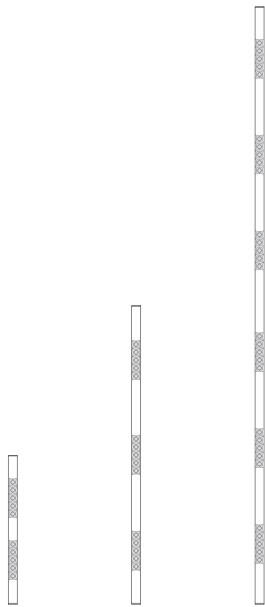

Ordering Guide

ID	Dimension	Wood Connector
8311	90 x 90 x 80	L Connector
8312	151 x 82 x 80	V Connector
8313	174 x 174 x 80	Y Connector
8314	160 x 90 x 80	T Connector
8315	160 x 160 x 80	+ Connector
8316	160 x 46 x 80	- Connector

Evo Dot ID + Wood Connector ID

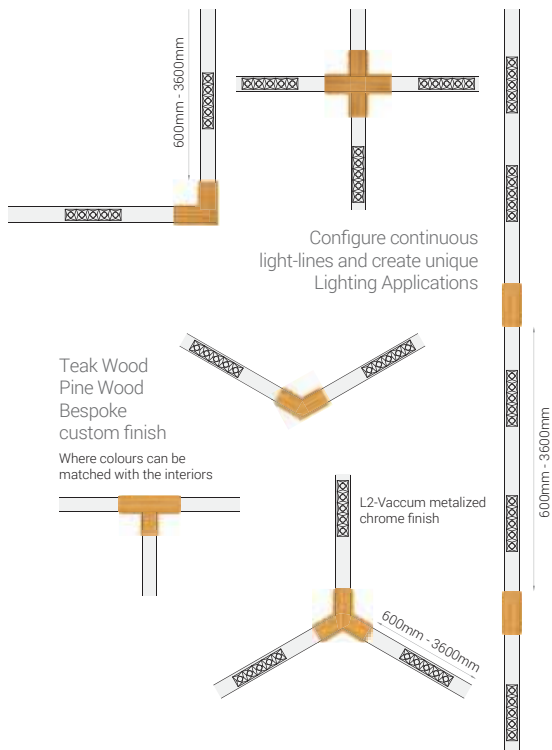

Dimension in mm

ID : 8311
L Wood Connector

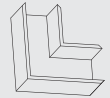
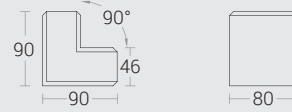

ID : 8312
V Wood Connector

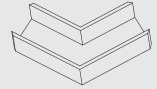
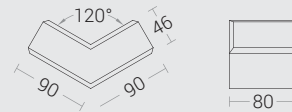

ID : 8313
Y Wood Connector

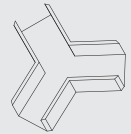
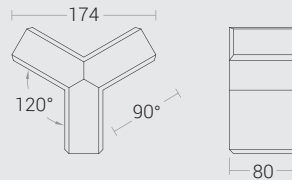

ID : 8314
T Wood Connector

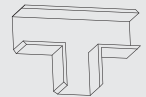
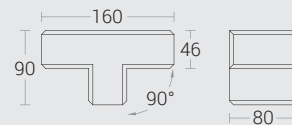

ID : 8315
+ Wood Connector

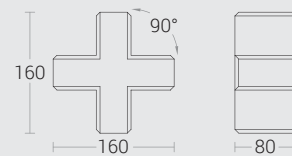

ID : 8316
- Wood Connector

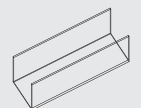

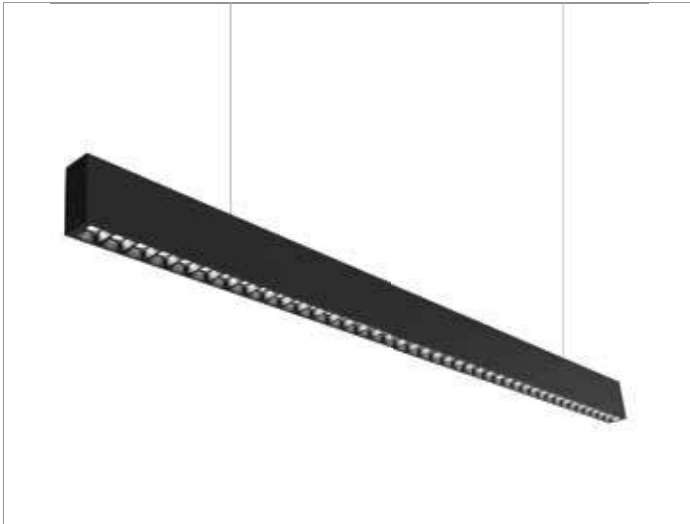

REVO

Pendant - Direct

ID	Wattage	Dimension (mm)
3465	Upto 40W	1188 x 36 x 75
3467	Upto 80W	2365 x 36 x 75
3468	Upto 120W	3540 x 36 x 75

Pendant - Direct & Indirect

3427	Upto 40W & 15W	1188 x 36 x 75
3447	Upto 80W & 30W	2365 x 36 x 75
3448	Upto 120W & 45W	3540 x 36 x 75

Surface

3443	Upto 40W	1188 x 36 x 75
3445	Upto 80W	2365 x 36 x 75
3519	Upto 120W	3540 x 36 x 75



EVO

Pendant - Direct / Direct-Indirect

ID	Wattage	Dimension (mm)
3469 / 3452	Upto 20W / Upto 20W & 8W	612 x 36 x 75
3520 / 3522	Upto 40W / Upto 40W & 15W	1212 x 36 x 75
3521 / 3523	Upto 80W / Upto 80W & 30W	2412 x 36 x 75

Surface

3457	Upto 20W	612 x 36 x 75
3524	Upto 40W	1212 x 36 x 75
3525	Upto 80W	2412 x 36 x 75

Wall Wash - Pendant / Surface

2825 / 2822	Upto 20W	612 x 36 x 75
2826 / 2823	Upto 40W	1212 x 36 x 75
2827 / 2824	Upto 80W	2412 x 36 x 75



EVO DOT

Pendant - Direct

ID	Wattage	Dimension (mm)
3470	Upto 20W	600 x 36 x 75
3471	Upto 30W	1200 x 36 x 75
3472	Upto 60W	2400 x 36 x 75
3473	Upto 90W	3600 x 36 x 75

Pendant - Direct-Indirect

3453	Upto 20W & 8W	600 x 36 x 75
3454	Upto 30W & 15W	1200 x 36 x 75
3455	Upto 60W & 30W	2400 x 36 x 75
3456	Upto 90W & 45W	3600 x 36 x 75

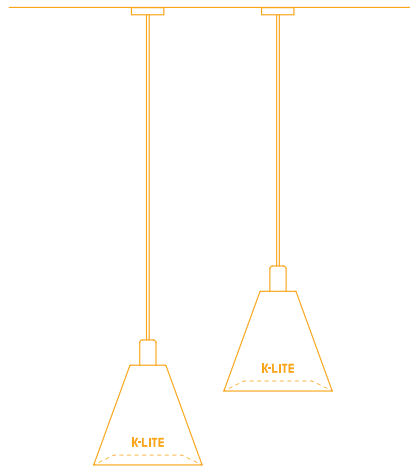

ARC

Elegance of Simplicity

Arc-L & D Pendant Direct / Indirect luminaire, offers high quality, economical and easy to install modular lighting solutions. It offers premium lighting environment for sustainable Offices, Educational institutions, Retail and General areas. High-performance optic for maximum light efficiency and glare controlled light distribution with low UGR.



ARC-L

Pendant - Direct

ID	Wattage	Dimension (mm)
3477	Upto 40W	1188 x 60 x 56
3478	Upto 80W	2364 x 60 x 56
3479	Upto 120W	3540 x 60 x 56

Pendant - Direct-Indirect

3429	Upto 40W & 15W	1188 x 60 x 56
3439	Upto 80W & 30W	2364 x 60 x 56
3440	Upto 120W & 45W	3540 x 60 x 56

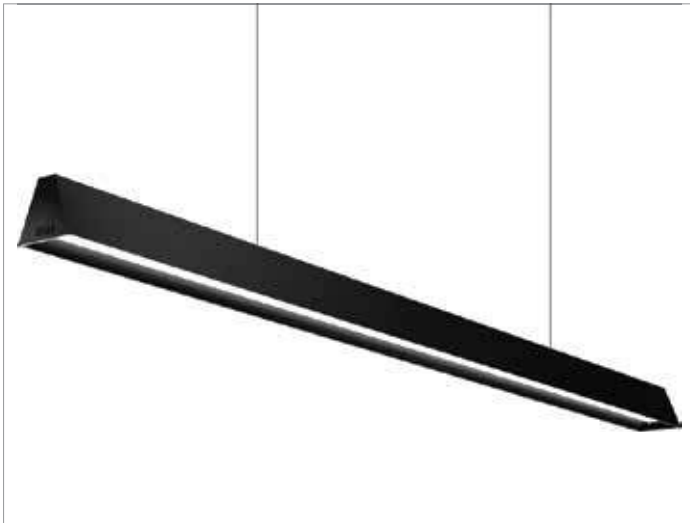

ARC-D

Pendant - Direct

ID	Wattage	Dimension (mm)
3481	Upto 40W	1200 x 60 x 56
3482	Upto 80W	2395 x 60 x 56
3483	Upto 120W	3585 x 60 x 56

Pendant - Direct-Indirect

3436	Upto 40W & 15W	1200 x 60 x 56
3437	Upto 80W & 30W	2395 x 60 x 56
3438	Upto 120W & 45W	3585 x 60 x 56



TRIO

Pendant - Direct

ID	Wattage	Dimension (mm)
3485	Upto 40W	1200 x 60 x 56
3486	Upto 80W	2395 x 60 x 56

Pendant - Direct-Indirect

3434	Upto 40W & 15W	1200 x 60 x 56
3441	Upto 80W & 30W	2395 x 60 x 56

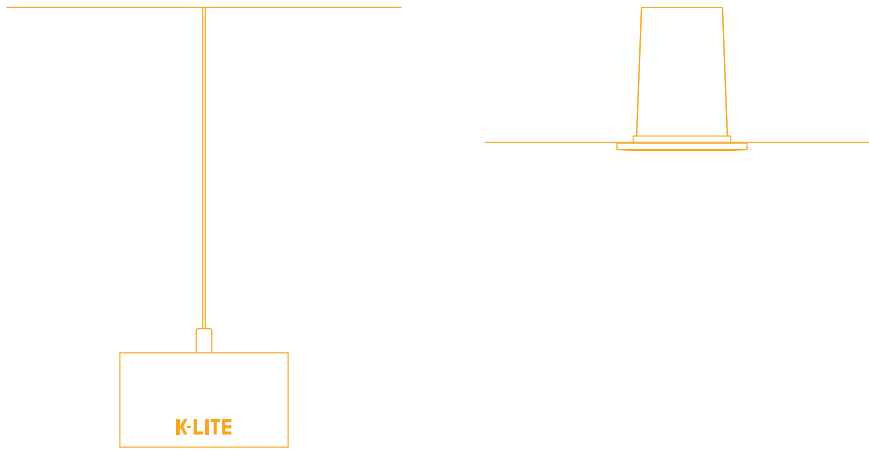

RIO / IVO

Low UGR.
Ideal for offices

Bringing quality light with cost-savings. Due to its length and low UGR, it delivers a homogenous and efficient distribution of light and reduces the luminaires per room. Therefore, it is most suitable for high-end offices, corridors, foyers, supermarkets, conference rooms, classrooms and other spacious environments.



RIO

Pendant - Direct

ID	Wattage	Dimension (mm)
3474	Upto 40W	612 x 66 x 37
3475	Upto 80W	1212 x 66 x 37

Pendant - Direct-Indirect

3461	Upto 40W & 20W	612 x 66 x 37
3425	Upto 80W & 40W	1212 x 66 x 37

Wall Light - Direct / Direct-Indirect

3515	Upto 40W	612 x 123 x 37
3516	Upto 40W & 20W	612 x 123 x 37



IVO

Recess

ID	Wattage	C.O.D	Dimension (mm)
3458	Upto 20W	602 x 36	615 x 45 x 50
3459	Upto 40W	1202 x 36	1215 x 45 x 50
3538	Upto 80W	2402 x 36	2415 x 45 x 50

Recess - Wall Wash

3487	Upto 20W	602 x 36	615 x 45 x 50
3488	Upto 40W	1202 x 36	1215 x 45 x 50
3539	Upto 80W	2402 x 36	2415 x 45 x 50



VIO

Recess

ID	Wattage	C.O.D	Dimension (mm)
3543	Upto 40W	1208 x 55	1215 x 62 x 45

IP65

K-LITE

Deep

Power : Upto 40W Upto 80W
Length : 1210mm 2402mm

Upto
100
lm/w

Features

- Lumiled / Equivalent LED's
- CRI Ra>80 (>90 On Request)
- SDCM ≤ 3
- L80 / B10 @ 50,000 Hrs
- Standard suspension kit 1M



Options

- CCT : 3000K / 4000K / 5700K
- Driver options



Beam Angle

BA120°

Diffused

Accessories

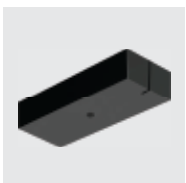

Canopy Kit for Dimmable options

K-LITE 138

Pendant-direct

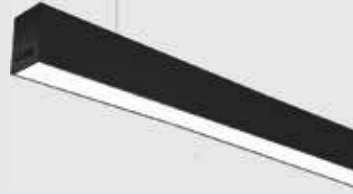

Pendant-direct / Indirect



Dimension in mm

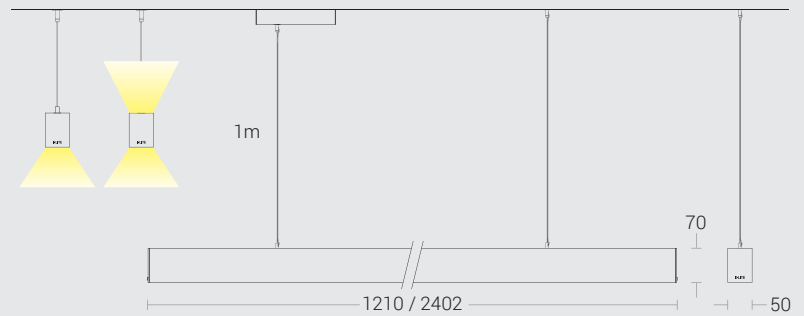

Housing Colour

- Extruded aluminium with powder coated finish in
RAL9005 Black fine texture | RAL9016 White fine texture |
RAL9006 Grey fine texture

Light Distribution

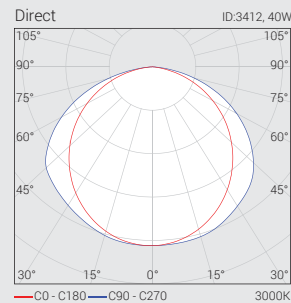

Prismatic

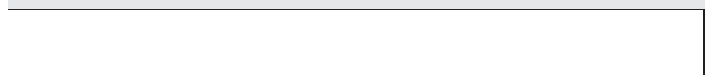

PC Opal Matte

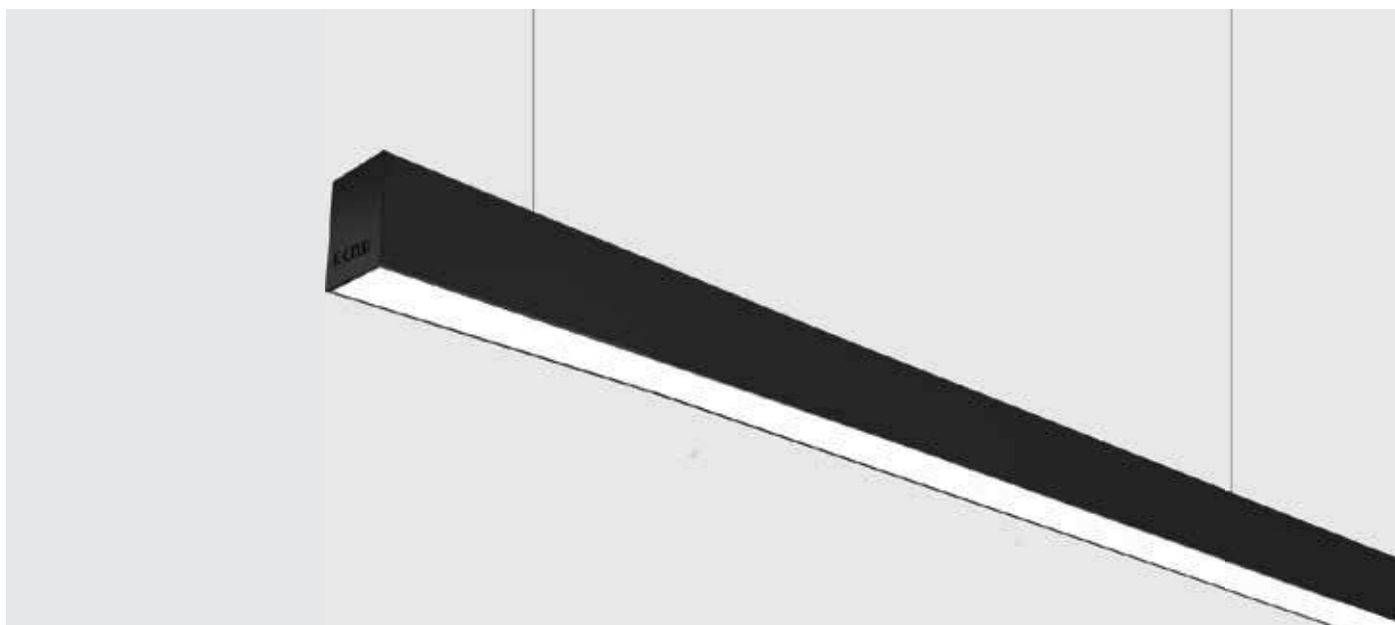

Technical Specifications

General

Driver	: Constant Current
Input Voltage	: 198-264Vac
Operating Temperature	: -15°C~+50°C

Light Source

Light Source	: Lumiled / Equivalent
LED Lumens	: 4500 lm / 6000 lm
CRI (Ra)	: >80 (>90 On Request)
LED Colour Temperature	: 3000K / 4000K / 5700K

Optical

Tilt	: Fixed
Beam Angle	: 120°
Diffuser Material	: Polycarbonate
Diffuser Finish	: Opal Matte / Prismatic
UGR	: <19

Physical

Body	: Extruded Aluminium with Die-cast Endcaps
Mounting	: Pendant
Finish	: Black(RAL9005) White(RAL9016) Grey(RAL 9006)

Driver

Power Supply	: Integral
Power Factor	: >0.90
THD	: <10%
Surge Protection	: 2KV-3KV
Efficiency	: >85%



Ordering Guide

Direct - Opal Matte

ID	Wattage	Dimension (mm)
3412	Upto 40W	1210 x 50 x 70
3531	Upto 80W	2402 x 50 x 70

Direct - Prismatic

ID	Wattage	Dimension (mm)
3532	Upto 40W	1210 x 50 x 70
3533	Upto 80W	2402 x 50 x 70

Direct - Indirect - Opal Matte

ID	Wattage	Dimension (mm)
3534	Upto 40W & 15W	1210 x 50 x 70
3535	Upto 80W & 30W	2402 x 50 x 70

Direct-Prismatic & Indirect-Opal Matte

ID	Wattage	Dimension (mm)
3536	Upto 40W & 15W	1210 x 50 x 70
3537	Upto 80W & 30W	2402 x 50 x 70

INSPIRATION



Open Source

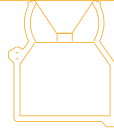

POWER GRAZE

Minimalistic Design
Maximum Lighting Effect

Power Graze emphasises the tactile qualities of architectural materials. The grazing light brings out the finest wood concrete or natural stone texture thereby enabling the luminaire to set off historic features or regional materials.

The resulting special rendering of vertical illuminance combines strikingly illuminated texture for scenic effect with efficient room lighting for places such as restaurants and hotels.

K-LITE

Power Graze

Power : Upto 18W Upto 36W Upto 72W
 Length : 610mm 1210mm 2410mm

>100
lm/w

Features

- Osram LED's
- CRI Ra>90
- SDCM \leq 3
- L70 / B10 @ 60,000 Hrs



Options

- CCT : 3000K / 4000K / 5700K
- Driver options
- Suitable for Double / Triple height ceiling

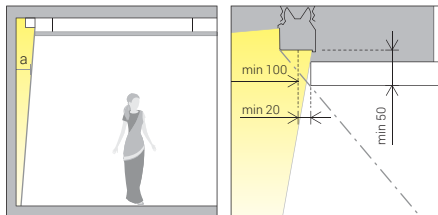

Excellent visual comfort

Due to the small installation dimensions of Power Graze, the luminaires remain concealed and thus support ideal visual comfort. Asymmetrical light distribution, this wall grazer can be positioned up to 10cm close to the wall and still produce an exceptionally uniform beam for ceiling height upto 10mtrs height.

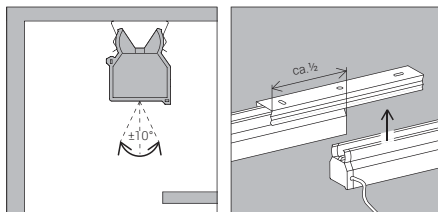

Tiltable by 10°

After installation, Power Graze can be tilted by +/- 10° within the mounting profile to optimise the light distribution along the wall. Continuous line installation The Power Graze luminaires can be installed in a continuous line to achieve maximised and uniform illuminance distribution on the wall.

Ceiling



Dimension in mm

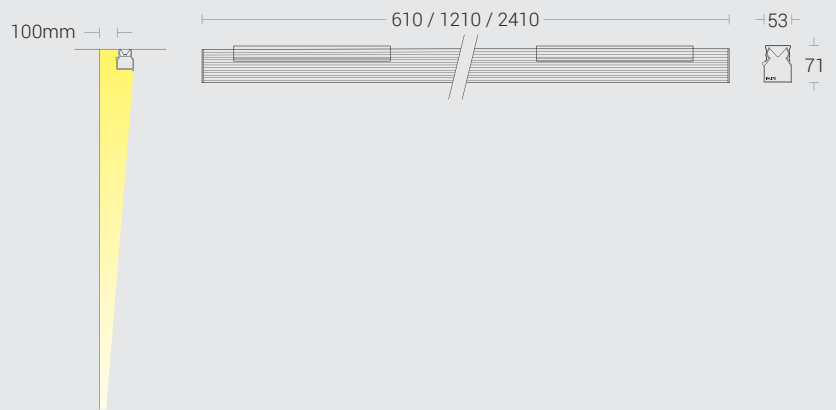

Light Distribution

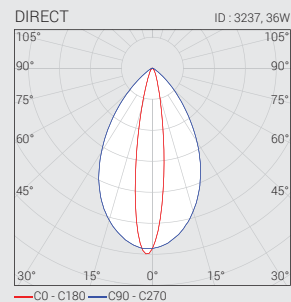

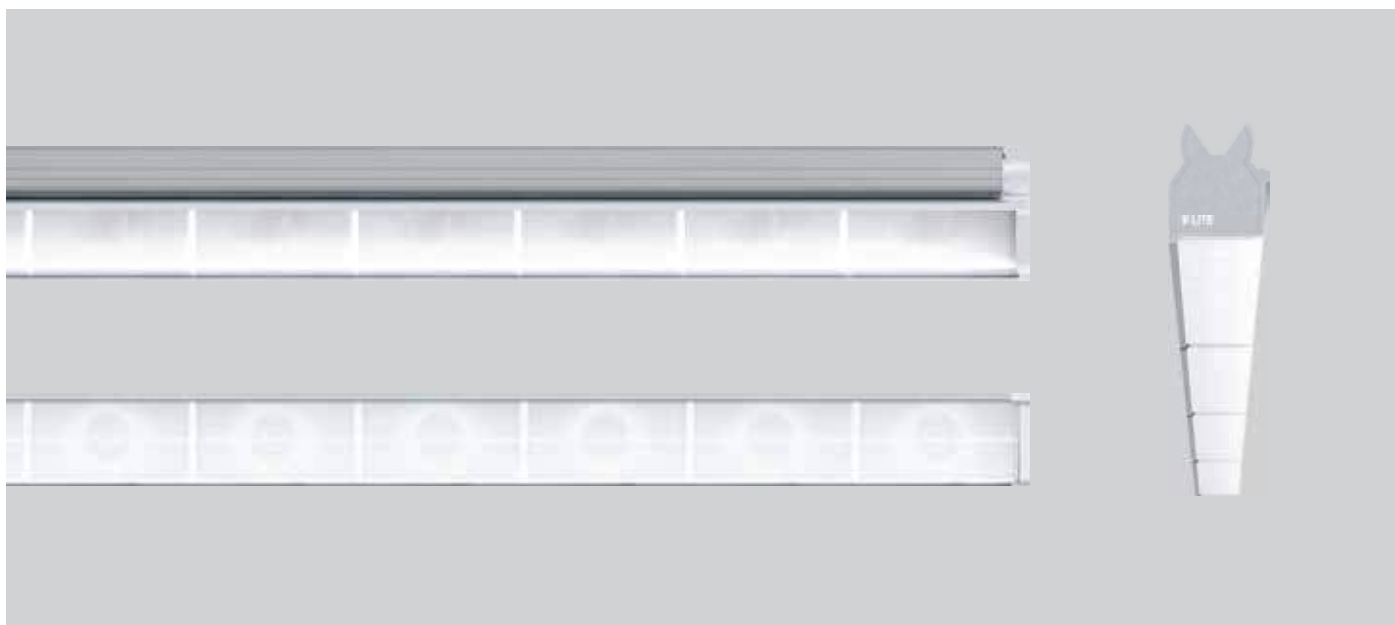

Technical Specifications

General

Driver	: Constant Current
Input Voltage	: 220-240Vac
Operating Temperature	: -15°C~+50°C

Light Source

Light Source	: Osram
CRI (Ra)	: >90
R9	: >50
LED Colour Temperature	: 3000K / 4000K / 5700K

Optical

Tilt	: 10°
Beam Angle	: 6°
Diffuser Material	: Polycarbonate
Secondary optics	: Elliptical Optical Polymer
UGR	: <19

Physical

Body	: Aluminium profile
Mounting	: Surface Mounted as continuous band of light
Diffuser	: Secondary optics made optical polymer
Fixing Clip	: Metal, Black powder coated

Driver

Power Supply	: Integral
Power Factor	: >0.9 - >0.97
THD	: <10%
Surge Protection	: 4KV
Efficiency	: >85%



Ordering Guide

Surface

ID	Wattage	Dimension (mm)
3384	Upto 18W	610 x 53 x 71
3237	Upto 36W	1210 x 53 x 71
3385	Upto 72W	2410 x 53 x 71

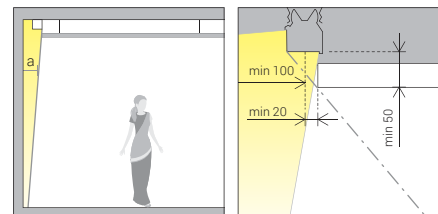

Excellent visual comfort

Due to the small installation dimensions of Power Graze, the luminaires remain concealed and thus support ideal visual comfort. Asymmetrical light distribution, this wall grazer can be positioned up to 10cm close to the wall and still produce an exceptionally uniform beam for ceiling height upto 10mtrs height.

INSPIRATION



Open Source

Mini Grazer



K-LITE's Grazer is a minimalistic functional powder coated aluminum profile with PMMA extruded lens which provides a high degree of robustness. This makes it possible to create infinite lines of light without any dark spots.

The varied optics enable the possibility to adapt Grazer-21 to the specific project requirements. The 30° optic is made for accent and decorative light and the 60° optic is best for wall washing and the combination of these optics makes a wide range of interior lighting application possible.

Product Description

- Luminaire made of extruded aluminium for better thermal management.
- Satin PMMA extruded lens.
- Designed for mounting on wall or ceiling.
- Cable groove provided for better cable management.
- Constant voltage LED driver, low voltage at 24V dc assures safety.
- Protection class IP44
- Suitable for operation on external driver, single phase ac supply.

Product Benefits

- Attractive high quality robust housing.
- Sturdy construction in order to maintain performance of the luminaire.
- Quick & simple installation.
- Flexible deployment options with a wide spectrum of applications.

Area of Application

Hotel & Resorts, Staircase Lighting, Malls, Shopping Complex, Commercial & Business Centers, Residential Lighting, Garden and similar applications.

K-LITE

Mini Grazer

Power : Upto 10W Upto 20W Upto 30W Upto 40W
 Length : 520mm 1020mm 1520mm 2020mm

Upto
70
lm/w

Features

- Lumileds LED's
- CRI Ra>80 (>90 On Request)
- SDCM \leq 3
- L80 / B10 @ 60,000 Hrs
- Standard suspension kit 1M



Options

- CCT : 2700K / 3000K / 4000K / 5700K / RGB
(Other colours On request)
- Driver options



Beam Angle



Installation

Ceiling / Floor mounting



Description
 Mounting clips
 Recommended to use every
 500mm.

Pendant

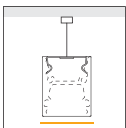

Description
 Adjustable stainless steel
 suspension kit (1 metre)
 available on request.

Wall mounted adjustable

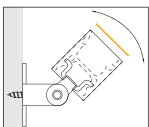

Mounting accessories
 Adjustable wall clamp mount ($\pm 60^\circ$)

Mono Colour



RGB



Dimension in mm

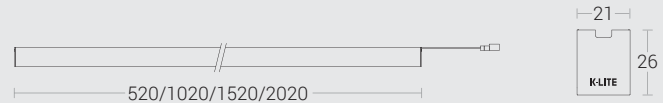

Application Idea

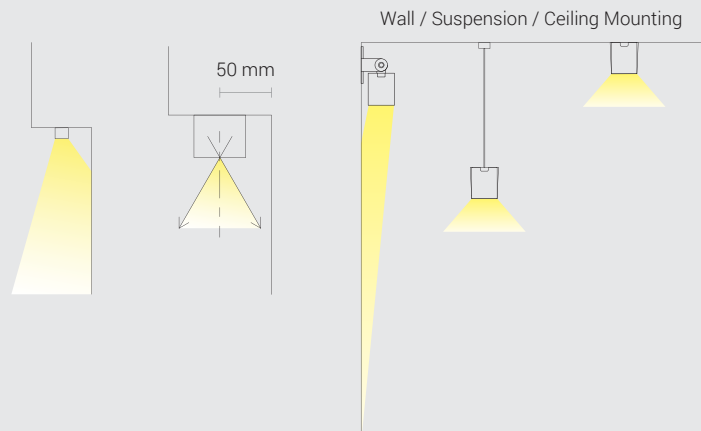

Housing Colour



Extruded aluminium with powder coated finish in
 RAL9005 Black fine texture | RAL9016 White fine texture

Light Distribution

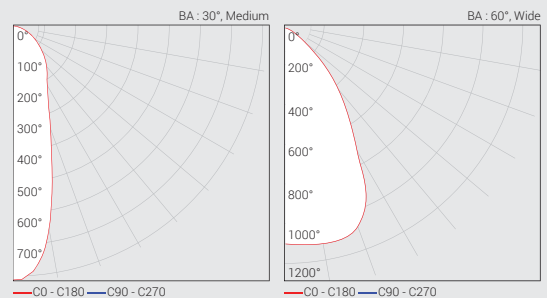

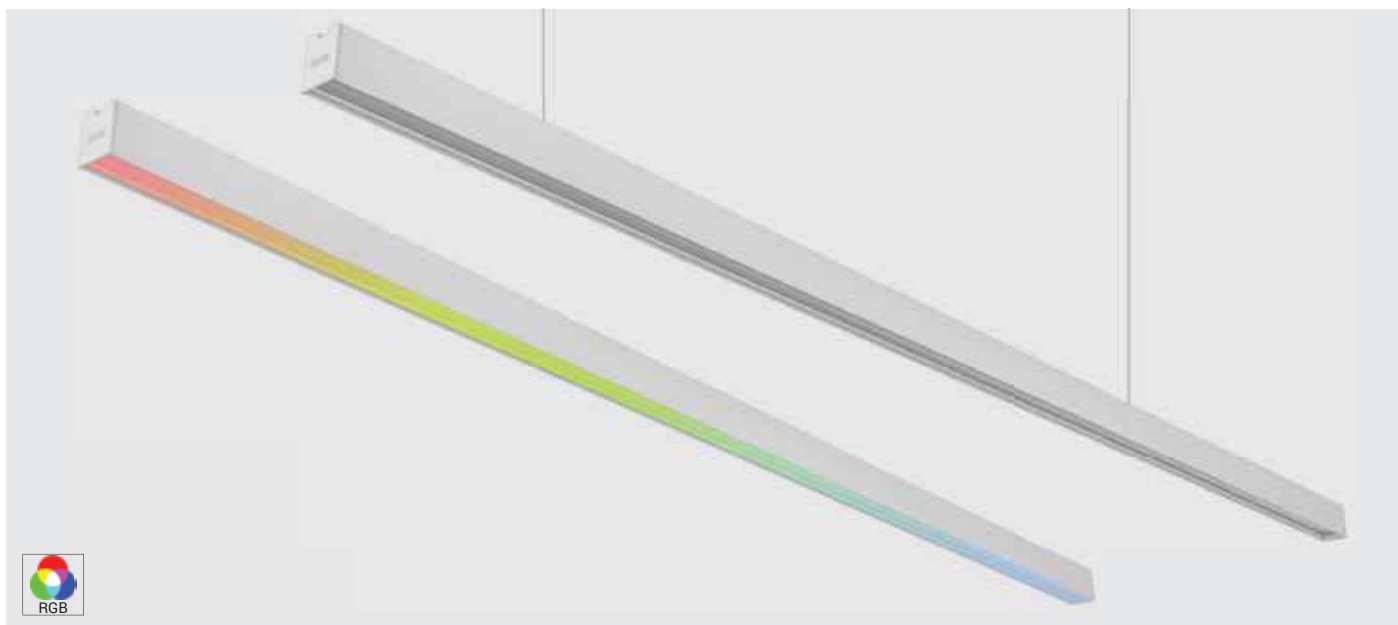

Technical Specifications

General

Driver	: Constant Voltage
Input Voltage	: 220-240Vac
Operating Temperature	: -15°C~+50°C
Operating Voltage	: 24Vdc
Power Supply	: Non Integral 24V PSU

Light Source

Light Source	: Lumileds
CRI (Ra)	: >80 (>90 On Request)
LED Colour Temperature	: 2700K / 3000K / 4000K / 5700K / RGB (Special colours on request)

Optical

Tilt	: Fixed
Beam Angle	: 30° / 60°
Luminaire Efficiency	: Upto 70 lm/W / Upto 67 lm/W
Diffuser Material	: Clear PMMA extruded lens

Physical

Body	: Extruded Aluminium with Translucent Endcaps
Mounting	: Surface / Tilttable
Finish	: Black(RAL9005) / White(RAL9016)

Specification

Power (W/m)	20W/m
Max.length (m)	2 mts



Ordering Guide

Pendant - Direct

ID	Wattage	Dimension (mm)
2828	Upto 10W	520 x 21 x 26
2829	Upto 20W	1020 x 21x 26
2830	Upto 30W	1520 x 21x 26
2831	Upto 40W	2020 x 21x 26

Surface

ID	Wattage	Dimension (mm)
2832	Upto 10W	520 x 21 x 26
2833	Upto 20W	1020 x 21x 26
2834	Upto 30W	1520 x 21x 26
2835	Upto 40W	2020 x 21x 26

Surface - RGB

ID	Wattage	Dimension (mm)
2836	Upto 10W	520 x 21 x 26
2837	Upto 20W	1020 x 21 x 26
2838	Upto 30W	1520 x 21 x 26
2839	Upto 40W	2020 x 21 x 26

K-LITE

Neo

Power : Upto 40W Upto 80W
Length : 1210mm 2402mm

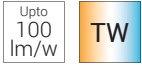

Features

- Bridgelux / Equivalent LEDs
- CRI Ra>80 (>90 On Request)
- SDCM ≤ 3
- L70 / B10 @ 60,000 Hrs
- Standard suspension kit 1M



Options

- CCT : 3000K / 4000K / 5700K or TW 2700K to 5700K
- Driver options



Beam Angle



Diffused

Accessories



Canopy Kit for Control gear

Pendant - Direct

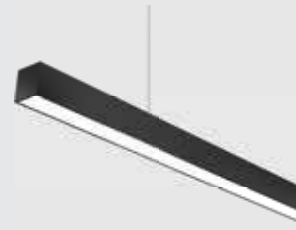

Dimension in mm

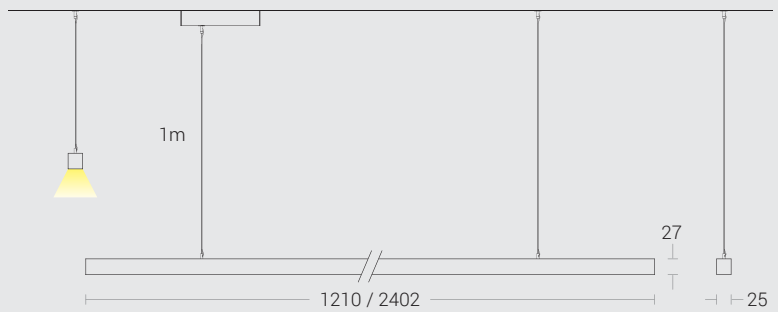

Housing Colour



Extruded aluminium with powder coated finish in
RAL9005 Black fine texture | RAL9016 White fine texture |
RAL9006 Grey fine texture

Light Distribution refer online

Super slim - 25mm

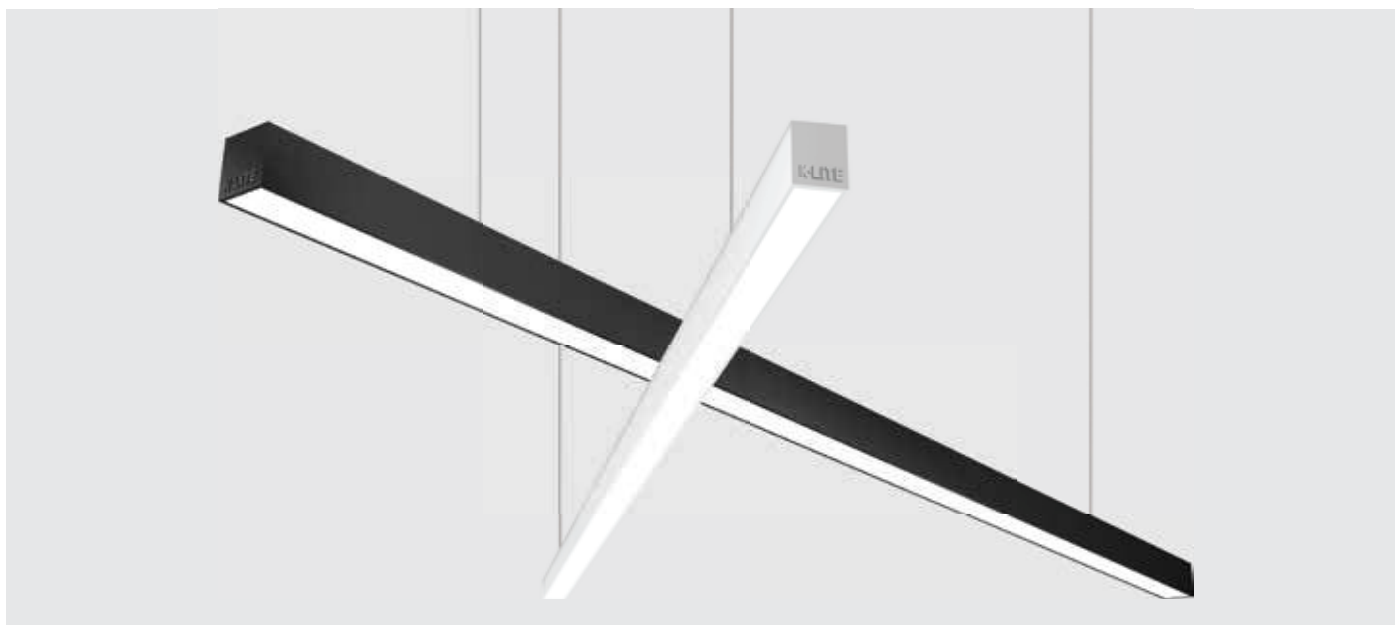

Technical Specifications

General

Driver : Constant Current
 Input Voltage : 220-240Vac
 Operating Temperature : -15°C~+50°C

Light Source

Light Source : Bridgelux / Equivalent
 CRI (Ra) : >80 (>90 On Request)
 LED Colour Temperature : 3000K / 4000K / 5700K

Optical

Tilt : Fixed
 Beam Angle : 100°
 Diffuser Material : Polycarbonate
 Diffuser Finish : Opal

Physical

Body : Extruded Aluminium
 with Die-cast Endcaps
 Mounting : Pendant
 Finish : Black(RAL9005)
 White(RAL9016)
 Grey (RAL 9006)

Driver

Power Supply : Integrated
 Power Factor : >0.90
 THD : <10%
 Surge Protection : Upto 3KV
 Efficiency : >85%



Ordering Guide

Pendant - Direct

ID	Wattage	Dimension (mm)
3497	Upto 40W	1210 x 25 x 27
3498	Upto 80W	2402 x 25 x 27

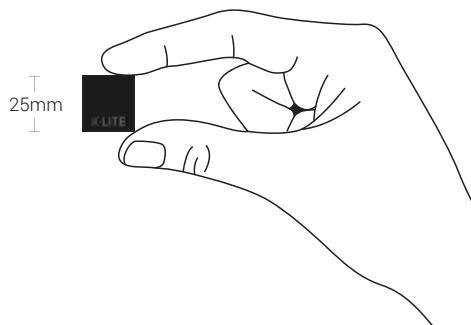

K-LITE

Power Wash

Power : Upto 40W Upto 80W
Length : 1214mm 2400 mm

Upto
100
lm/w

Features

- Bridgelux / Equivalent LED's
- CRI Ra>80 (>90 On Request)
- SDCM ≤ 3
- L70 / B10 @ 60,000 Hrs



Options

- CCT : 3000K / 4000K / 5700K
- Driver options



K-LITE 150

Recess



Dimension in mm

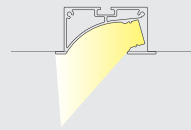
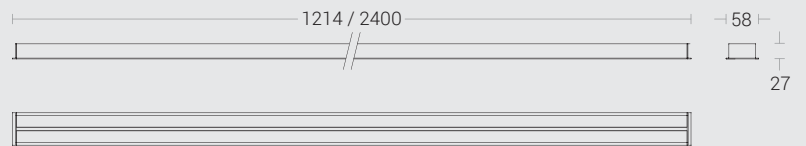

Housing Colour

- ● Extruded aluminium with powder coated finish in
RAL9016 White fine texture | RAL9006 Grey fine texture

Light Distribution

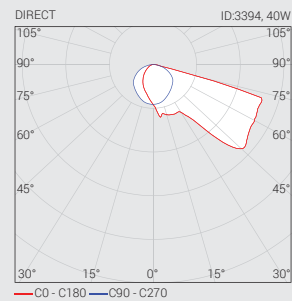

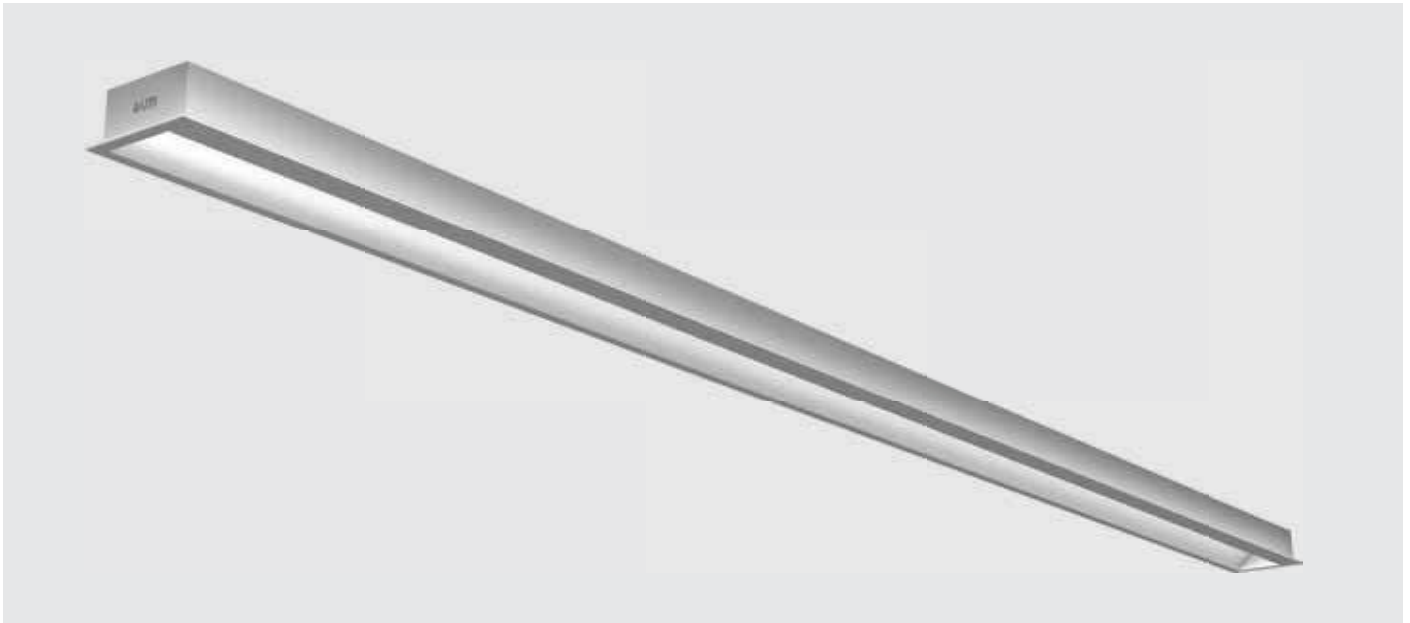

Technical Specifications

General

Driver	: Constant Current
Input Voltage	: 220-240Vac
Operating Temperature	: -15°C~+50°C

Light Source

Light Source	: Bridgelux / Equivalent
CRI (Ra)	: >80 (>90 On Request)
LED Colour Temperature	: 3000K / 4000K / 5700K

Optical

Tilt	: Fixed
Diffuser/Lens Material	: PC Opal diffuser
UGR	: <19

Physical

Body	: Extruded Aluminium with Endcaps
Mounting	: Recess
Finish	: White(RAL9016) Grey (RAL 9006)

Driver

Power Supply	: Integrated
Power Factor	: >0.95
THD	: <10%
Surge Protection	: Upto 3KV
Efficiency	: >85%



Ordering Guide

Recess

ID	Wattage	C.O.D	Dimension (mm)
3394	Upto 40W	1205 x 50	1214 x 58 x 27
3395	Upto 80W	2391 x 50	2400 x 58 x 27

INSPIRATION



Open Source

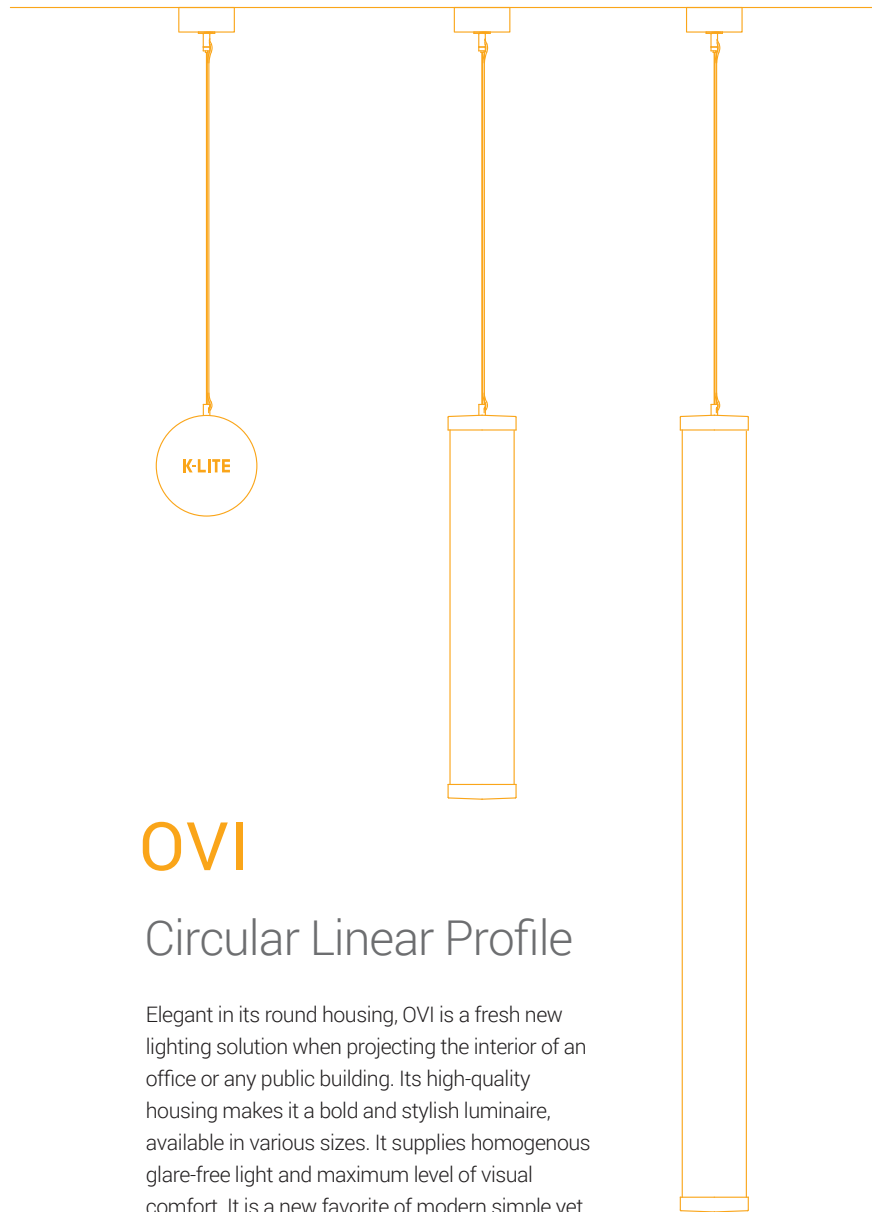

OVI

Circular Linear Profile

Elegant in its round housing, OVI is a fresh new lighting solution when projecting the interior of an office or any public building. Its high-quality housing makes it a bold and stylish luminaire, available in various sizes. It supplies homogenous glare-free light and maximum level of visual comfort. It is a new favorite of modern simple yet stylish office lighting.

K-LITE

Ovi

Power : Upto 20W Upto 40W Upto 80W
Length : 570mm 1085mm 2110mm



Features

- Lumiled / Equivalent LED's
- CRI Ra>80 (>90 On Request)
- SDCM ≤ 3
- L70 / B10 @ 60,000 Hrs
- Standard suspension kit 1M



Options

- CCT : 3000K / 4000K / 5700K or TW 2700K to 5700K
- Driver options



Beam Angle - BA360°



Accessories

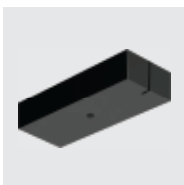

Canopy Kit for Dimmable options

Pendant



Dimension in mm

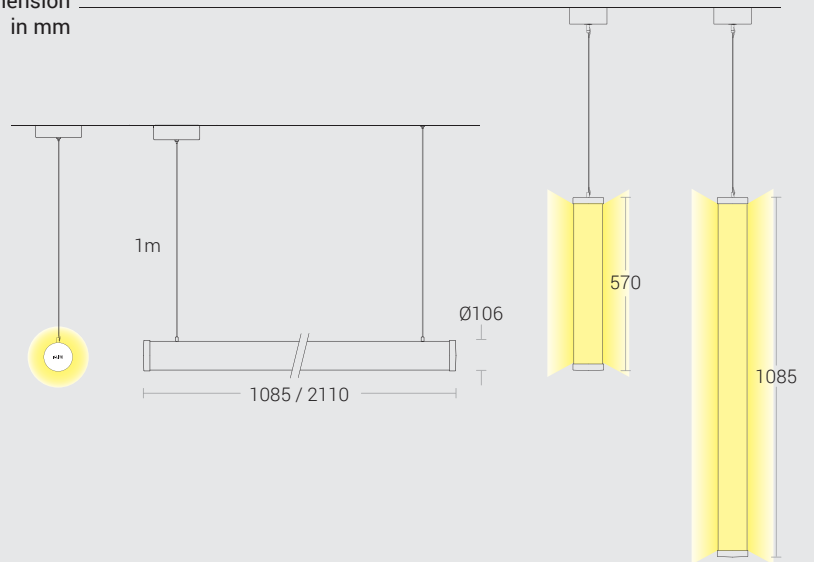

Housing Colour



Die-cast aluminium Endcaps with powder coated finish in RAL9005 Black fine texture | RAL9006 Grey fine texture. Sparkle Gold (Liquid Paint).

Light Distribution refer online



Technical Specifications

General

Driver : Constant Current
 Input Voltage : 220-240Vac
 Operating Temperature : -15°C~+50°C

Light Source

Light Source : Lumiled / Equivalent
 CRI (Ra) : >80 (>90 On Request)
 LED Colour Temperature : 3000K / 4000K / 5700K

Optical

Tilt : Fixed
 Beam Angle : 360°
 Diffuser Material : Opal Polycarbonate
 UGR : <16

Physical

Body : Polycarbonate Tube with Die-cast Endcaps
 Mounting : Pendant
 Finish : Black (RAL9005)
 Grey (RAL9006)
 Sparkle Gold (Liquid Paint)

Driver

Power Supply : Integrated
 Power Factor : >0.95
 THD : <10%
 Surge Protection : 3KV
 Efficiency : >85%



Ordering Guide

Pendant

ID	Wattage	Dimension (mm)
3462	Upto 40W	1085 x Ø106
3463	Upto 80W	2110 x Ø106

Pendant - Vertical

ID	Wattage	Dimension (mm)
3495	Upto 20W	570 x Ø106
3496	Upto 40W	1085 x Ø106

ID : 3496



12V SERIES WATERPROOF POWER SUPPLY

ID	Wattage	Output Current	IP
8357	15W	1.25A	67
8191	30W	2.5A	67
8192	60W	5A	67
8205	100W	8.33A	67
8193	150W	12.5A	67

24V SERIES WATERPROOF POWER SUPPLY

ID	Wattage	Output Current	IP
8196	30W	1.25A	67
8197	60W	2.5A	67
8198	150W	6.25A	67
8199	200W	8.33A	67
8200	300W	12.5A	67

FLEXIBLE LED STRIP - ACCESSORIES

ID	Description
8350	144W RGBW Controller with remote kit



24V SERIES NON-WATERPROOF POWER SUPPLY

ID	Wattage	Output Current
8358	48W	2A
8252	72W	3A
8253	144W	6A
8254	240W	10A

Accessories

CONNECTORS

<p>8160</p> <p>8325 / 8184</p> <p>IP68</p>	<p>IP67</p>
8325 Two Way Connector-4 Pin PG9	8185 Three Way Connector
8184 Two Way Connector-3 Pin PG9	Suitable for cable 6mm - 10mm
8160 Two Way Connector - 3 Pin	

<p>IP68</p>	<p>IP68</p>
8324 Two Way Connector-2 Pin	8300 Two/Three Way Gel Connector
8326 Two Way Connector-4 Pin	

CONTROLLERS

<p>8110</p>	<p>8114</p>	
8110 RGB Controller	8114 RGB Signal Amplifier	8304 RGB Controller
		Only suitable for Linear Wall Washer

JUNCTION BOX

<p>128 x 83 x 226</p>	<p>128 x 82 x 245</p>	<p>128 x 82 x 495</p>
8344 Wall Mounting	8345 Floor Mounting	8346 Spike Mounting

Box for electronic power supply

Cable IN : 2 Nos. cable glands M10

Cable OUT : 6 Nos. cable glands M10

IP65 CLASS II SELV

The total power of all connected luminaires may not be higher than the power of the driver

Review of Applied Symbols

LUMINAIRES

- N7 Armstrong / Gypsum / 'T' Section False Ceiling - 600 Series.
- N8 Supplied with adjustable stainless steel suspension kit (1 metre).
- N10 Polycarbonate Base
- N11 Up / Down Lighter.
- N12 UpDown Lighter.
- N13 Down Lighter.

A12 : Clear Polycarbonate diffuser

C.O.D : Cutout Dimension.

WW : Warm White (2700-3000K).

NW : Neutral White (4000-4200K).

CW : Cool White (5700-6500K).

SS : Stainless Steel Body.

TR : Translucent.

T1 : Track to be ordered separately.

R1 : Rates offered are exclusive of poles and brackets.

 : Asymmetrical Light Distribution

Max. Wattage

E27-A : 13W LED / 11W CFL.

E27-B : 13W LED / 20W CFL.

E27-C : 17W LED / 23W CFL.

E27-D : 30W LED / 45W CFL.

E27-E : 11W LED / 20W CFL.

MOUNTING DETAILS

D1 Post Top Lantern suitable for mounting on 50mm OD pipe.

D2 Luminaires suitable for mounting on 60mm OD Pipe.

D3 Post Top Lantern suitable for mounting on 76mm OD pipe.

D4 Suitable for mounting to internally threaded pipe of designation : M30.

D6 Suitable for mounting on 38mm OD pipe.

D7 Suitable for mounting Horizontal on 48mm & Vertical on 60mm OD pipe.

D8 Bracket suitable for mounting on Swaged pipe to 52mm OD of 200mm Height.

D12 Suitable for mounting Horizontal & Vertical on 60mm OD pipe.

D13 Suitable for mounting on 101mm OD pipe.

D14 Suitable for mounting Horizontal & Vertical on 48mm OD pipe.

D15 Suitable for mounting on 72mm Square pipe.

D16 Suitable for mounting on 91mm Square pipe.

D21 Suitable for mounting on swaged pipe to 52mm OD of 140mm Height.

D22 Suitable for mounting on swaged pipe to 68mm OD of 140mm Height.

D23 Suitable for mounting on swaged pipe to 81mm OD of 140mm Height.

D26 Luminaires suitable for mounting on 88.9mm OD Pipe.

D27 Suitable for side mounting on 100mm Square pipe.

D28 Suitable for side mounting on 80mm Square pipe.

Terms and Conditions

General Conditions

- K-Lite reserves the right to discontinue any products from its range at any time whatsoever and without prior notice.
- K-Lite also reserves the right to make technical and photometric modifications as well as to change any parts, details or finishes deemed suitable for improvement purposes and commercial requirements.
- The pole & product compositions shown in the catalogue are merely indicative.
- The data and information contained in these pages is to be considered indicative and non-binding K-Lite reserves the right to cancel, alter, or rectify the data and information for technical and technological reasons.
- K-Lite will try to do everything in its power to ensure that all the data and information herein are correct and up-to-date when printed, yet shall not be held accountable if, regardless of various proofreads, there should be inaccuracies or error because that are out of K-Lite control.
- Sketches are not to scale. General manufacturing tolerances are applicable to the dimensions furnished. All dimensions are in mm.

Guarantee

- K-Lite warrants that their products are free from any defect in manufacturing and / or material in case of proper use.
- Products / Solutions should be used within their specifications (e.g. Temperature, water ingress, IP rating for indoor / outdoor installations) and according to application guidelines. Please refer to installation guidelines available on the web page www.klite.in
- Warranty becomes void if the product is improperly applied and if the damage is caused by improper use or installation.
- K-Lite luminaire if subsequently modified, the persons responsible for the modification shall be considered as manufacturer.
- Fundamental failure's that will not be considered for warranty
 - (a) Short circuit in the input part while connecting the wires.
 - (b) Excess heating up of the frame due to which failure in the operation of the driver, control gear or LED.
 - (c) Physical damage of any components or product, due to improper handling.

Information

- For enquiries, information and update www.klite.in
- All rights reserved. Reproduction in whole or in part is prohibited.
- Disputes, if any, are subject to CHENNAI jurisdiction only.

Available Finish

Pure polyester powder coated

- Graphite grey
- Anthracite grey
- Jet black

Floor Mounting Luminaires - Mounting Details

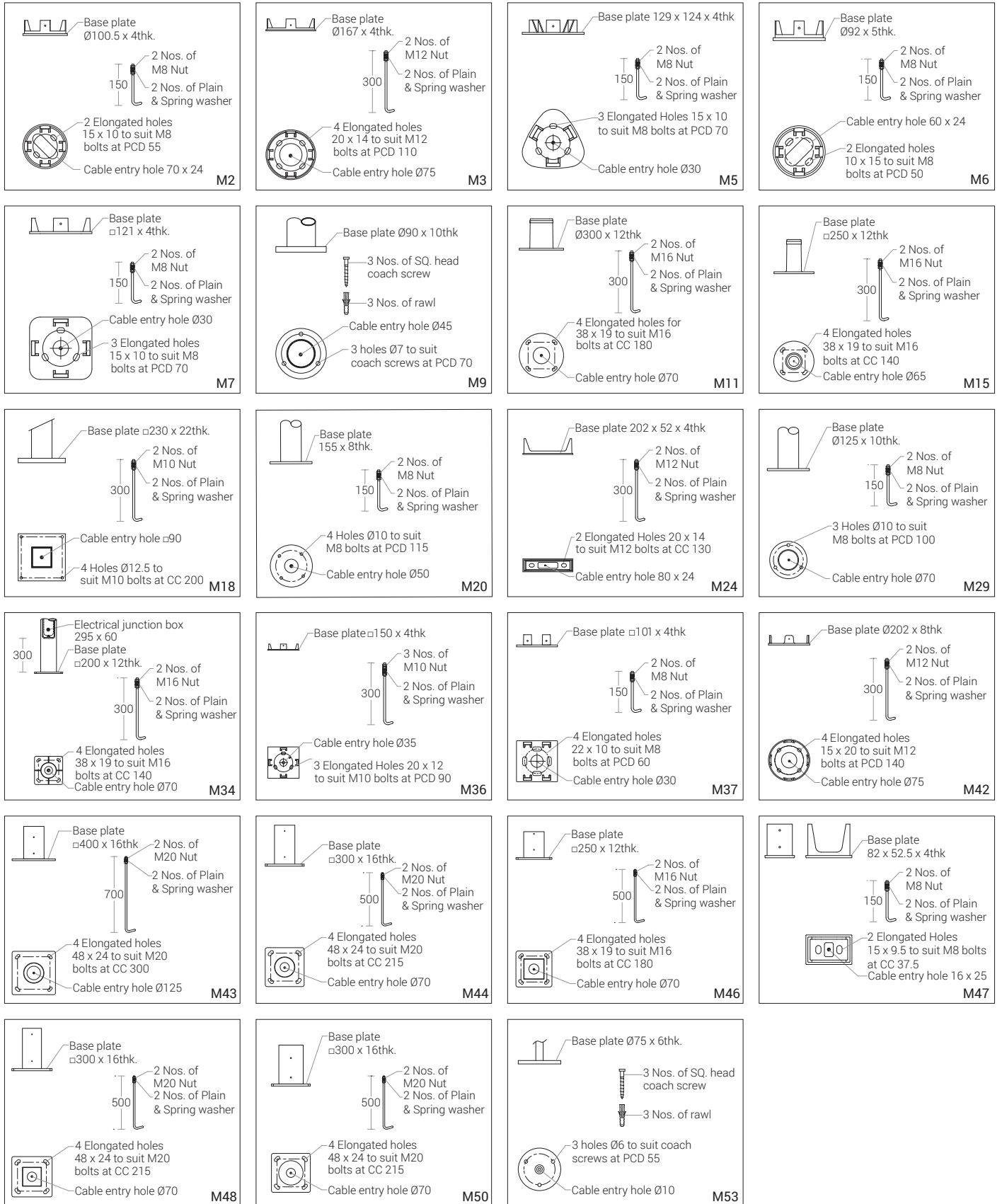

Anchor Fasteners, Coach screws and Rawlplugs are not included in scope of supply.

Wall Brackets - Mounting Details

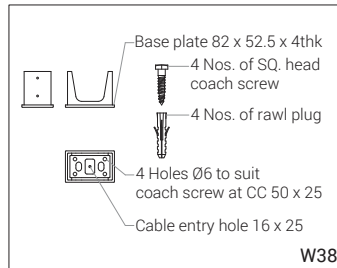
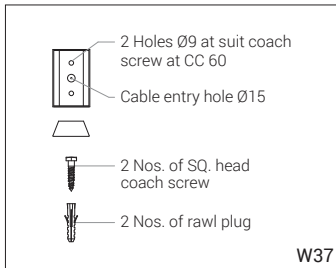
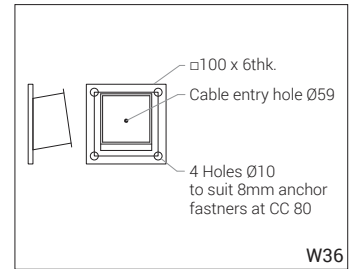
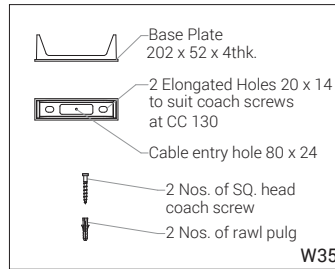
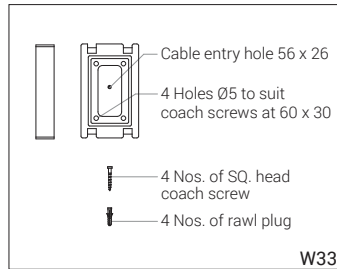
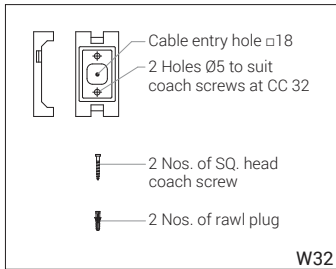
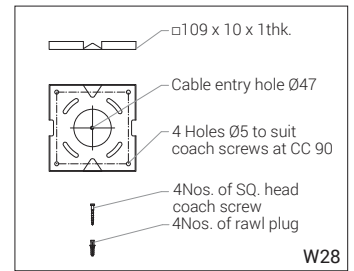
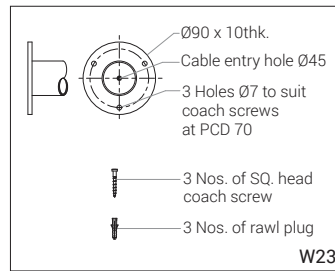
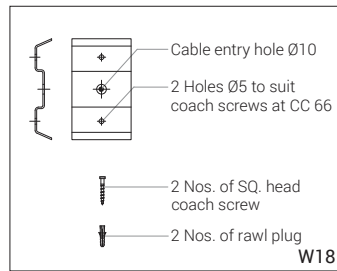
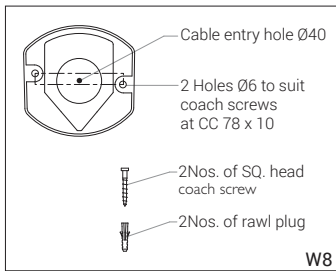

Quick Reference

Luminaires

ID	Pg.	ID	Pg.	ID	Pg.	ID	Pg.	ID	Pg.	ID	Pg.	ID	Pg.	ID	Pg.	ID	Pg.	ID	Pg.	ID	Pg.				
1588	110	3009	111	3328	121	3458	137	3560	79	3810	96	4243	44	4441	99	4671	12	4968	101	5583	11	7200	19	8282	52
1589	110	3022	111	3329	121	3459	137	3561	79	3980	124	4244	52	4442	99	4672	12	4969	101	5591	11	7204	19	8283	52
2281	110	3045	111	3330	121	3461	137	3562	79	4046	35	4245	52	4443	99	4673	12	4970	100	5592	11	7208	19	8284	52
2287	110	3052	111	3331	123	3462	155	3563	79	4049	35	4247	44	4444	98	4680	12	4971	98	5616	35	7212	19	8285	52
2735	41	3053	111	3332	115	3463	155	3569	71	4055	35	4261	52	4445	98	4681	12	4975	86	5633	35	7281	126	8286	52
2741	41	3054	111	3333	121	3465	133	3570	71	4058	35	4262	50	4446	98	4682	12	4976	86	5634	35	7289	126	8293	78
2742	41	3055	111	3334	121	3467	133	3571	73	4070	35	4263	49	4447	98	4695	11	4977	86	6300	96	7331	110	8295	48
2743	41	3066	60	3335	121	3468	133	3572	73	4074	35	4264	49	4448	98	4704	11	4978	89	6420	53	7332	110	8296	48
2745	41	3067	60	3336	121	3469	133	3585	77	4075	35	4265	49	4449	103	4705	11	4979	91	6466	56	7333	110	8297	53
2746	41	3068	60	3337	123	3470	133	3587	83	4082	43	4266	49	4469	57	4706	11	4980	91	6583	96	7348	124	8298	53
2747	41	3070	60	3338	121	3471	133	3588	83	4083	43	4267	49	4472	57	4707	11	4983	85	6700	64	7349	124	8299	53
2750	40	3078	51	3339	121	3472	133	3589	83	4084	43	4268	49	4473	57	4708	16	4984	85	6707	64	7350	124	8300	156
2753	41	3082	127	3342	110	3473	133	3590	83	4085	55	4269	49	4474	57	4709	14	4985	85	6740	64	7399	19	8304	156
2755	41	3084	126	3343	110	3474	137	3591	81	4086	55	4270	49	4492	87	4710	16	4986	85	6788	53	7511	19	8305	53
2757	41	3092	60	3345	121	3475	137	3592	81	4089	56	4275	49	4493	87	4718	11	4998	88	6789	53	7543	19	8306	48
2761	40	3094	60	3349	123	3477	135	3593	81	4090	56	4276	49	4502	87	4719	11	4999	88	6790	96	7544	19	8307	48
2763	40	3098	125	3351	115	3478	135	3594	81	4092	56	4283	49	4503	87	4720	21	5000	89	6791	91	7555	45	8308	48
2766	38	3099	125	3352	115	3479	135	3612	108	4093	56	4284	49	4506	88	4722	21	5027	87	6798	53	7576	43	8309	48
2767	38	3100	125	3353	115	3481	135	3613	108	4097	57	4285	52	4509	88	4724	21	5040	87	6799	91	7600	19	8310	48
2768	40	3113	125	3354	115	3482	135	3614	108	4098	57	4286	52	4510	86	4726	16	5071	85	6800	90	7673	19	8311	132
2769	40	3174	111	3355	115	3483	135	3615	69	4105	64	4287	52	4514	88	4727	16	5072	85	6802	85	7736	123	8312	132
2770	40	3175	111	3356	111	3485	135	3616	69	4107	56	4288	52	4515	88	4728	16	5073	85	6803	85	7803	115	8313	132
2776	38	3187	125	3359	110	3486	135	3617	69	4109	64	4290	94	4516	89	4729	16	5076	85	6805	52	7807	115	8314	132
2777	41	3188	125	3360	110	3487	137	3618	69	4116	64	4291	94	4517	89	4730	16	5084	85	6951	12	7814	115	8315	132
2820	113	3189	125	3369	116	3488	137	3619	77	4127	64	4292	94	4518	89	4731	14	5087	85	6952	12	7819	115	8316	132
2821	113	3190	125	3370	116	3490	115	3620	77	4129	64	4304	96	4520	86	4732	14	5088	85	6953	12	7824	115	8317	68
2822	133	3206	115	3371	116	3491	115	3621	75	4130	64	4336	26	4521	87	4734	38	5131	96	6954	12	7897	33	8318	68
2823	133	3207	115	3372	116	3495	155	3622	75	4131	64	4338	26	4522	87	4735	24	5132	96	6955	13	7898	33	8319	61
2824	133	3225	127	3373	116	3496	155	3623	75	4132	64	4339	26	4523	87	4737	26	5133	96	6956	13	7945	126	8320	61
2825	133	3226	127	3374	117	3497	149	3624	75	4133	56	4343	38	4524	87	4748	26	5138	91	6957	13	8110	156	8321	61
2826	133	3227	127	3375	117	3498	149	3628	43	4134	56	4352	26	4535	12	4749	14	5139	91	6963	12	8114	156	8322	61
2827	133	3230	62	3376	117	3515	137	3629	43	4135	56	4367	99	4536	12	4750	30	5150	96	6964	12	8160	156	8323	48
2828	147	3232	111	3377	117	3516	137	3632	43	4136	56	4368	99	4543	12	4754	29	5175	34	6965	12	8177	122	8324	156
2829	147	3237	143	3378	117	3519	133	3634	33	4137	56	4370	102	4544	12	4755	29	5187	90	6976	16	8178	122	8325	156
2830	147	3240	62	3379	116	3520	133	3635	33	4140	57	4371	102	4553	21	4756	34	5188	91	6977	16	8179	62	8326	156
2831	147	3245	73	3381	117	3521	133	3636	33	4141	57	4372	102	4554	21	4758	15	5189	89	6978	16	8180	62	8330	59
2832	147	3247	71	3384	143	3522	133	3637	33	4142	57	4373	102	4555	21	4759	15	5192	89	6984	33	8184	156	8331	78
2833	147	3251	71	3385	143	3523	133	3638	33	4144	56	4374	102	4556	21	4761	15	5268	34	6985	33	8185	156	8333	48
2834	147	3254	73	3394	151	3524	133	3639	33	4146	57	4375	102	4583	24	4762	15	5311	91	6988	50	8191	156	8334	48
2835	147	3256	69	3395	151	3525	133	3640	33	4158	96	4391	93	4584	24	4763	17	5353	89	6998	50	8192	156	8335	48
2836	147	3265	69	3401	129	3527	63	3643	43	4159	96	4392	93	4585	24	4764	17	5368	86	7018	28	8193	156	8336	48
2837	147	3266	69	3408	128	3528	63	3644	43	4160	96	4413	104	4587	30	4773	17	5372	89	7020	28	8196	156	8337	48
2838	147	3267	69	3412	139	3531	139	3645	43	4163	97	4414	104	4588	26	4778	13	5373	89	7021	28	8197	156	8339	52
2839	147	3270	59	3419	128	3532	139	3646	43	4164	97	4415	104	4589	26	4789	15	5380	87	7030	30	8198	156	8340	52
2840	129	3272	59	3425	137	3533	139	3647	43	4171	96	4416	104	4607	90	4790	15	5383	87	7034	30	8199	156	8341	52
2841	129	3274	59	3427	133	3534	139	3649	43	4174	97	4417	104	4608	90	4823	13	5384	87	7036	28	8200	156	8342	80
2842	113	3275	59	3429	135	3535	139	3650	33	4175	97	4418	104	4612	90	4825	13	5435	88	7042	30	8205	156	8343	48
2843	113	3276	59	3431	115	3536	139	3651	33	4176	96	4419	104	4620	90	4827	13	5436	88	7052	50	8242	49	8344	156
2848	113	3277	59	3432	115	3537	139	3652	33	4184	19	4420	104	4621	90	4841	14	5444	87	7057	50	8243	49	8345	156
2850	113	3278	59	3434	135	3538	137	3653	33	4185	19	4421	105	4622	90	4842	14	5445	87	7062	13	8244	49	8346	156
2852	129	3280	59	3436	135	3539	137	3654	33	4186	19	4422	105	4623	91	4849	86	5477	86	7063	13	8245	49	8348	48
2853	129	3285	115	3437	135	3540	137	3655	33	4187	19	4423	105	4624	90	4850	86	5478	86	7064	13	8246	49	8349	48
2855	129	3286	115	3438	135	3541	137	3656	33	4194	50	4424	105	4625	26	4890	91	5493	86	7069	17	8247	49	8350	156
2856	129	3287	115	3439	135	3542	137	3665	34	4195	50	4425	106	4626	26	4891	91	5558	13	7078	19	8248	49	8351	122
2857	129	3296	115	3440	135	3543	137	3666	33	4200	53	4426	106	4627	26	4892	91	5559	13	7081	123	8252	156	8352	122
2858	129	3298	115	3441	135	3549	59	3667	33	4201	53	4427	106	4628	26	4893	91	5560	13</						



K-LITE

India's Lighting Company

D-10, Ambattur Industrial Estate, Chennai - 600 058.

T : 26257710, 48581950.

M: 95000 79797, 95000 85511

E : info@klite.in

W: www.klite.in

Unit II
23B,
SIDCO Industrial Estate,
Chennai - 600 098.

**Unit V
Illumination Lab**
G8, Ambattur Industrial Estate,
Chennai - 600 058.

K-LITE EUROPE LTD
T : 0208 012 8393
E : info@klite.co.uk
W : www.klite.co.uk

Unit III
179 & 180,
SIDCO Industrial Estate,
Chennai - 600 098.

Unit VI
22B,
SIDCO Industrial Estate,
Chennai - 600 098.

North London Showroom
271 Abbeydale Road,
Wembley, HA0 1TW.

Unit IV
Plot No.E29, E30, Industrial Area,
Phase-II, Mandideep Tehsil,
Goharganj District-462046.Raisen (MP).

Showroom
7/11, M.T.H. Road,
Chennai - 600 058.

Delhi Office - NCR
L-14/10, DLF City,
Phase - II, Gurgaon - 122002.
Haryana.